

Ersatzteilliste	G50.4 Kompressorsteuerung	MV2 (Mini-Verticus)
Spare parts catalogue	G50.4 Compressor control system	MV2 (Mini-Verticus)
Listes des pièces	G50.4 Dispositif de commande	MV2 (Mini-Verticus)

Baugruppe	Assembly	Assemblage	Bild/Fig.
79940 (3 kW; 380 - 440 V) Direktstart, halbautomatisch	79940 (3 kW; 380 - 440 V) Direct start, semi-automatic	79940 (3 kW; 380 - 440 V) Démarrage direct, semi-automatique	G50.4- 1
80113 (3 kW; 380 - 440 V) Direktstart, vollautomatisch	80113 (3 kW; 380 - 440 V) Direct start, automatic	80113 (3 kW; 380 - 440 V) Démarrage direct, automatique	G50.4- 2
79941 (4 kW; 380 - 340 V) Stern-Dreieck, halbautomatisch	79941 (4 kW; 380 - 440 V) Star-delta start, semi-automatic	79941 (4 kW; 380 - 440 V) Démarrage étoile-triangle, semi-automatique	G50.4- 3
79944 (4 kW; 380 - 440 V) Stern-Dreieck, vollautomatisch	79944 (4 kW; 380 - 440 V) Star-delta start, automatic	79944 (4 kW; 380 - 440 V) Démarrage étoile-triangle, automatique	G50.4- 4
79942 (5,5 kW; 380 - 440 V) Stern-Dreieck, halbautomatisch	79942 (5,5 kW; 380 - 440 V) Star-delta start, semi-automatic	79942 (5,5 kW; 380 - 440 V) Démarrage étoile-triangle, semi-automatique	G50.4- 5
79945 (5,5 kW; 380 - 440 V) Stern-Dreieck, vollautomatisch	79945 (5,5 kW; 380 - 440 V) Star-delta start, automatic	79945 (5,5 kW; 380 - 440 V) Démarrage étoile-triangle, automatique	G50.4- 6
80488 (3 kW; 220 - 240 V) Direktstart, halbautomatisch	80488 (3 kW; 220 - 240 V) Direct start, semi-automatic	80488 (3 kW; 220 - 240 V) Démarrage direct, semi-automatique	G50.4- 7
80491 (3 kW; 220 - 240 V) Direktstart, vollautomatisch	80491 (3 kW; 220 - 240 V) Direct start, automatic	80491 (3 kW; 220 - 240 V) Démarrage direct, automatique	G50.4- 8
79943 (4 kW; 220 - 240 V) Stern-Dreieck, halbautomatisch	79943 (4 kW; 220 - 240 V) Star-delta start, semi-automatic	79943 (4 kW; 220 - 240 V) Démarrage étoile-triangle, semi-automatique	G50.4- 9
79951 (4 kW; 220 - 240 V) Stern-Dreieck, vollautomatisch	79951 (4 kW; 220 - 240 V) Star-delta start, automatic	79951 (4 kW; 220 - 240 V) Démarrage étoile-triangle, automatique	G50.4- 10
80487 (5,5 kW; 220 - 240 V) Stern-Dreieck, halbautomatisch	80487 (5,5 kW; 220 - 240 V) Star-delta start, semi-automatic	80487 (5,5 kW; 220 - 240 V) Démarrage étoile-triangle, semi-automatique	G50.4- 11
80490 (5,5 kW; 220 - 240 V) Stern-Dreieck, vollautomatisch	80490 (5,5 kW; 220 - 240 V) Star-delta start, automatic	80490 (5,5 kW; 220 - 240 V) Démarrage étoile-triangle, automatique	G50.4- 12

Änder.-Nr. Change no. No. de change	Datum Date	Änderung	Change	Changement
0	01.06.1996	Grundausgabe	Basic edition	Edition de base
1	01.06.2000	Umstellung auf MV2	Change to MV2	Adaptation à MV2
2	01.07.2001	Phasenfolgewächter	Phase sequence control relay	Détecteur d'ordre des phases
3	01.02.2002	Öldrucküberwachung	Oil pressure monitoring	Surveill. de la pression d'huile
4	01.01.03	ÄM 7153	Change 7153	Modification 7153

Wichtige Hinweise für Teilebestellung:

Bestell-Nr., die mit der Ziffer 0 beginnen, bezeichnen Baugruppen, die komplett geliefert werden. Teile ohne Bestell-Nr. sind nur zur Information für die Montage aufgeführt. Sie sind nicht als Ersatzteil erhältlich. Bei Ersatzteilbestellungen erwarten Sie unsere richtige Lieferung; deshalb benötigen wir von Ihnen folgende Angaben (siehe unten gezeigtes Typenschild):

1. Modellbezeichnung, Fabrik-Nr. sowie Fertigungsstand von Anlage/Block
2. Stückzahlen
3. Benennung und Best.-Nr. des gewünschten Teils

Bestell-Beispiel:

Für Kompressorblock ...
Fabrik-Nr. 524-0528/1/2 drei Dichtungen
8263-090

Important notes for spare parts orders:

Part nos. beginning with digit 0 indicate parts available as complete assemblies. Parts without part no. are indicated for assembly reference, only. These parts are not available as single parts. When placing an order for spare parts, please give the following items so as to ensure our correct delivery (see identification plate shown below):

1. Model, serial no. as well as design standard of unit/block
2. Quantity required
3. Name and part no.

Example for order:

For compressor block ...
serial no. 524-0528/1/2, three gaskets
8263-090

Avis important pour la commande de pièces:

Les nos. de commande commençant par le chiffre 0 indiquent les pièces livrées au complet. Les pièces sans no. de commande sont indiquées uniquement pour information de montage. Elles ne sont pas livrées individuellement. Pour que la livraison de pièces de rechange corresponde à la commande, veuillez bien nous fournir les données suivantes (voir plaque d'identité ci-dessous):

1. Modèle, no. de série et standard de construction de bloc compresseur/groupe
2. Quantité désirée
3. Dénomination et no. de commande de la pièce désirée

Exemple de commande:

Pour bloc compresseur ...
no. de série 524-0528/1/2, trois joints no. de cde. 8263-090



Wartungssätze

- a =Wartungssatz 500 h
- b =Wartungssatz 1000 h
- c =Wartungssatz 2000 h



Maintenance kit

- a = Maintenance kit 500 h
- b = Maintenance kit 1000 h
- c = Maintenance kit 2000 h



Kits de pièces d'entretien :

- a = Kit d'entretien 500 h
- b = Kit d'entretien 1000 h
- c = Kit d'entretien 2000 h

In den Spalten sind die im entsprechenden Satz enthaltenen Teile angekreuzt. Bitte beachten, daß die höheren Sätze die untergeordneten nicht beinhalten, d.h. für eine 2000-Stunden-Wartung wird 1x Satz a, 1x Satz b und 1x Satz c benötigt.

The columns contain the parts that are included in the respective parts set. Please note that the higher graded kits do not include the lower ones, i.e. for a 2000 hours maintenance, one kit a, one kit b plus one kit c are required.

Les pièces contenues dans les kits correspondants sont marquées d'une croix dans les colonnes. Veuillez observer que les kits supérieurs ne contiennent pas les kits subordonnés, c'est-à-dire pour un entretien de 2000 heures il faut avoir 1x kit a, 1x kit b et 1x kit c.

**Anmerkungen zur Identifikation:
Remarks for identification:
Remarques pour l'identification:**

Modell/Model/Modèle		Fabrik-Nr./Serial no./Numéro de série	
<input type="checkbox"/>		<input type="checkbox"/>	
Volumenstrom m ³ /min	<input type="checkbox"/>	Jahr/Year	<input type="checkbox"/>
Free air delivery Scfm	<input type="checkbox"/>	n/min. r.p.m.	<input type="checkbox"/>
Betriebsüberdruck bar	<input type="checkbox"/>	kW	<input type="checkbox"/>
Max. working press. psig	<input type="checkbox"/>	KB 73708	<input type="checkbox"/>
		Fertigungsstand / Modification no. / No. de modification	
		Anlage/Unit/Groupe	
		Kompressorblock/ Compressor block/ Bloc compresseur	



ACHTUNG

Nur Schrauben und Stiftschrauben der Qualität 8.8 verwenden!



ATTENTION

Use only screws and studs in quality 8.8! This quality is equivalent to SAE J 429 d grade 5.



ATTENTION

N'utiliser que des vis et des goujons filetés de la qualité 8.8!

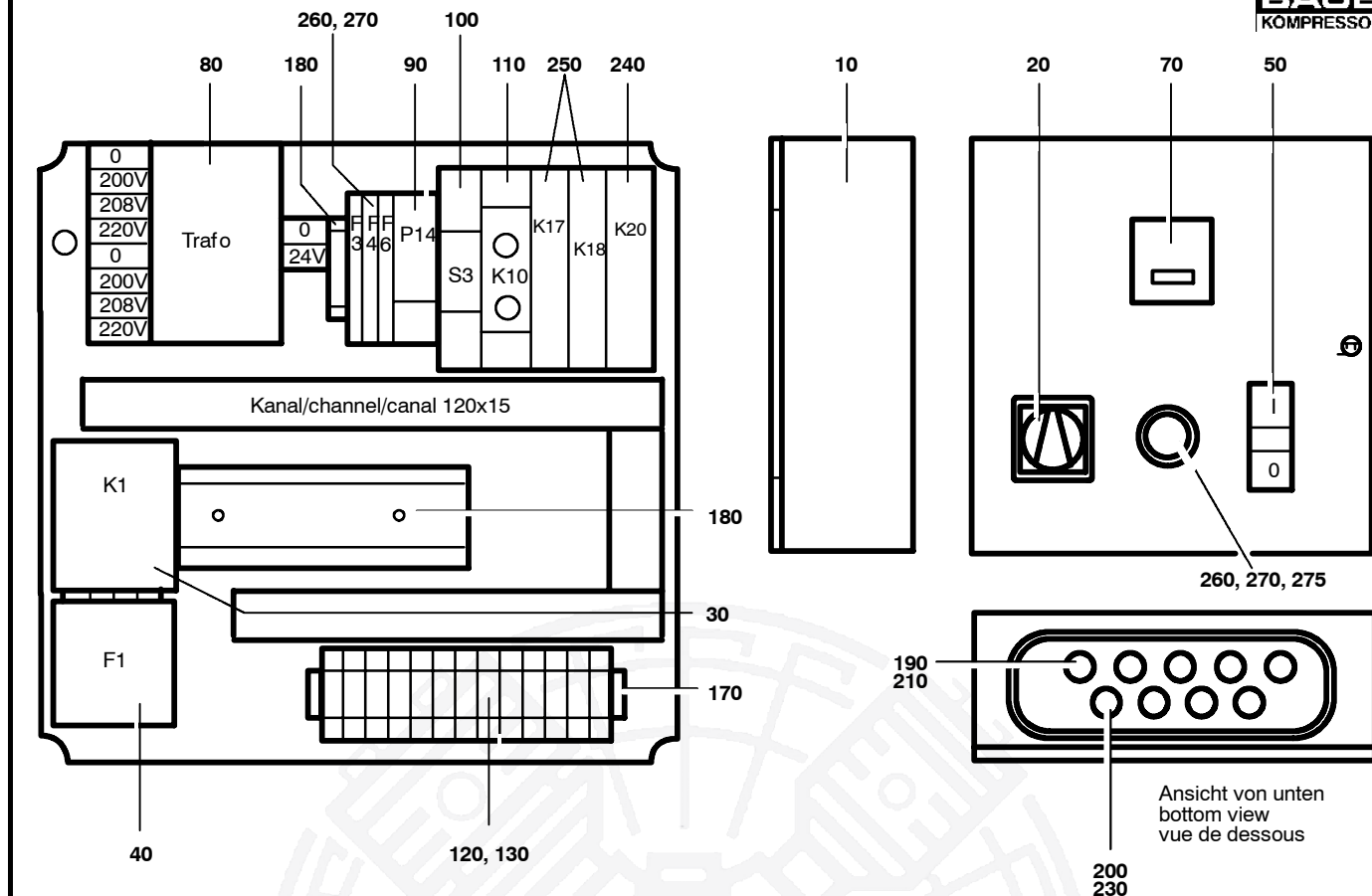

Ersatzteilsätze
 Spare parts sets
 Kits de pièces dét.

Baugruppe 79940
 Assembly 79940
 Assemblage 79940

Kompressorsteuerung 3 kW; 380 - 440 V halbautomatisch
 Compressor control unit 3 kW; 380 - 440 V semi-automatic
 Unité de commande 3 kW; 380 - 440 V semi-automatique

G50.4- 1

Klasse/ Class/ Classe			Pos.	Bestell-Nr. Part No. No. de cde.	Anz. Qty. Qté.	Benennung	Designation	Dénomination
a	b	c						
			10	N23779	1	Gehäuse	housing	boîtier
			20	N4555	1	Hauptschalter	main switch	interrupteur principal
			30	N26156	1	Motorschütz	motor contactor	disjoncteur moteur
			40	N26153	1	Überlastrelais	overload relay	relais de surcharge
			50	N26308	1	Tastschalter kpl.	dual push-button switch	interrupteur
			70	N23853	1	Betriebsstundenzähler	hour meter	compteur d'heures
			80	N23791	1	Steuertransformator	control transformer	transformateur
			90	N19096	1	Summierzähler	cycle counter	compteur/totalisateur
			100	N16206	1	Installationsschalter	installation switch	interrupteur d'installation
			110	N16202	1	Taktgeber	timer	minuterie électrique
			120	N23685	16	Durchgangsklemme	terminal clamp	borne de phase
			130	N23688	2	Schutzleiterklemme	ground terminal	borne de terre
			140	N23689	1	Abschlußplatte	end plate	plaque de fermeture
			150	N23690	2	Endwinkel	end bracket	angle de fermeture
			160	N23778	7	Querverbindung	cross connection	connexion latérale
			170	N4863	mm	Tragschiene	bearing rail	rail support
			180	N16126	mm	Tragschiene	carrying rail	rail support
			190	N3100	3	Kabelverschraubung	cable stuffing box coupling	raccord presse-étoupe
			200	N3101	6	Kabelverschraubung	cable union	raccord de câble
			210	N3103	3	Gegenmutter	counternut	contre-écrou
			230	N3104	6	Gegenmutter	counternut	contre-écrou
			240	N26439	1	Zeitrelais, Öldruck	time relay, oil pressure	relais, pression d'huile
			250	N22441	2	Schnittstellenrelais	intersection relay	relais d'interface
			260	N26443	1	Frontelement	front element red oil symbol	élément de façade
			270	N26313	1	LED-Element	LED element	LED
			275	N26310	1	Befestigungsflansch	mounting bracket	bride de fixation
			290	72827	1	Klebeschild	label	étiquette
			300	71410	1	Klebeschild	label	étiquette
			310	N22351	1	Klebeschild	label	étiquette

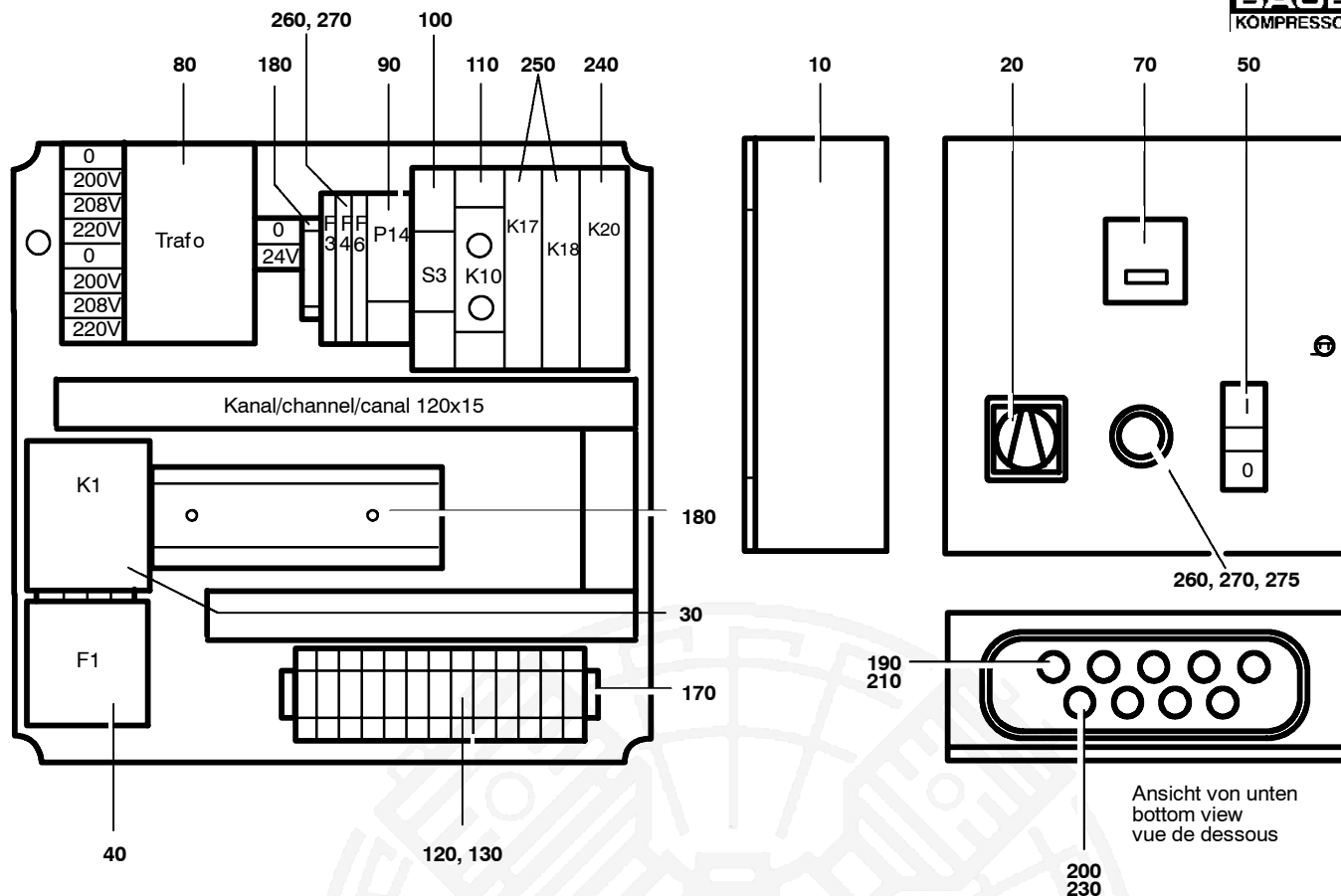

Ersatzteilsätze
Spare parts sets
Kits de pièces dét.

Baugruppe 79940 Kompressorsteuerung 3 kW; 380 - 440 V halbautomatisch
 Assembly 79940 Compressor control unit 3 kW; 380 - 440 V semi-automatic
 Assemblage 79940 Unité de commande 3 kW; 380 - 440 V semi-automatique

G50.4- 1

Klasse/ Class/ Classe			Pos.	Bestell-Nr. Part No. No. de cde.	Anz. Qty. Qté.	Benennung	Designation	Dénomination
a	b	c						
			--	N26437	1	Druckschalter, Oldruck	pressure switch, oil press.	électrovanne, pression d'huile
			--	N26438	1	Schutzkappe	protective cap	couvercle protecteur

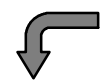
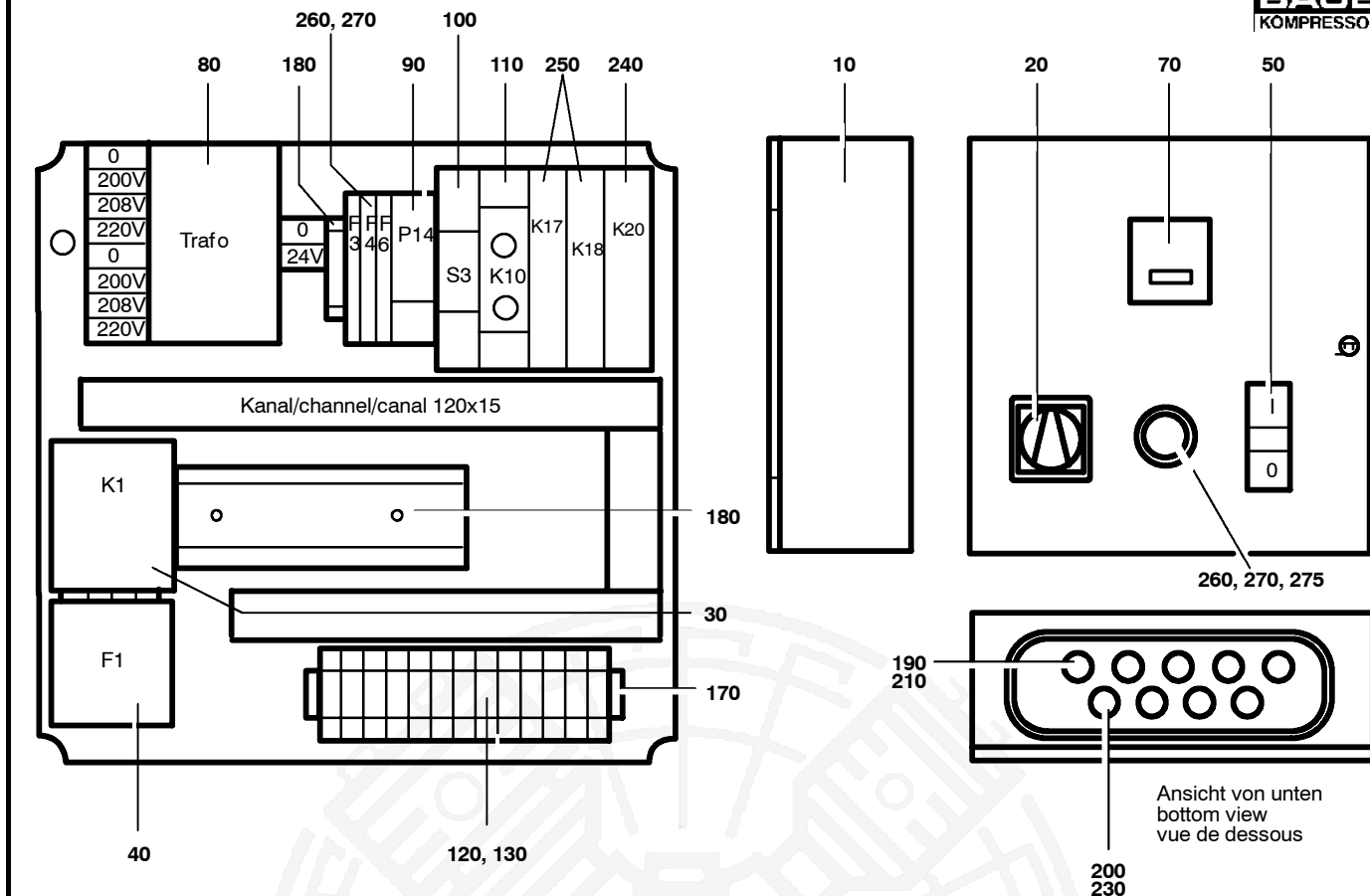

Ersatzteilsätze
 Spare parts sets
 Kits de pièces dét.

Baugruppe 80113 Kompressorsteuerung 3 kW; 380 - 440 V vollautomatisch
 Assembly 80113 Compressor control unit 3 kW; 380 - 440 V automatic
 Assemblage 80113 Unité de commande 3 kW; 380 - 440 V automatique

G50.4- 2

Klasse/ Class/ Classe			Pos.	Bestell-Nr. Part No. No. de cde.	Anz. Qty. Qté.	Benennung	Designation	Dénomination
a	b	c						
			10	N23779	1	Gehäuse	housing	boîtier
			20	N4555	1	Hauptschalter	main switch	interrupteur principal
			30	N26156	1	Motorschütz	motor contactor	disjoncteur moteur
			40	N26153	1	Überlastrelais	overload relay	relais de surcharge
			50	N26308	1	Tastschalter kpl.	dual push-button switch	interrupteur
			70	N23853	1	Betriebsstundenzähler	hour meter	compteur d'heures
			80	N23791	1	Steuertransformator	control transformer	transformateur
			90	N19096	1	Zyklenzähler	cycle counter	compteur/totalisateur
			100	N16206	1	Installationsschalter	installation switch	interrupteur d'installation
			110	N26809	1	Taktgeber	timer	minuterie électrique
			120	N23685	16	Durchgangsklemme	terminal clamp	borne de phase
			130	N23688	2	Schutzleiterklemme	ground terminal	borne de terre
			140	N23689	1	Abschlußplatte	end plate	plaque de fermeture
			150	N23690	2	Endwinkel	end bracket	angle de fermeture
			160	N23778	7	Querverbindung	cross connection	connexion latérale
			170	N4863	mm	Tragschiene	bearing rail	rail support
			180	N16126	mm	Tragschiene	carrying rail	rail support
			190	N3100	3	Kabelverschraubung	cable stuffing box coupling	raccord presse-étoupe
			200	N3101	6	Kabelverschraubung	cable union	raccord de câble
			210	N3103	3	Gegenmutter	counternut	contre-écrou
			220	N3104	6	Gegenmutter	counternut	contre-écrou
			230	N22441	2	Schnittstellenrelais	intersection relay	relais d'interface
			240	N26439	1	Zeitrelais, Öldruck	time relay, oil pressure	relais, pression d'huile
			250	N26443	1	Frontelement	front element red oil symbol	élément de façade
			260	N26313	1	LED-Element	LED element	LED
			270	N26310	1	Befestigungsflansch	mounting bracket	bride de fixation
			280	N22351	1	Klebeschild	label	étiquette
			290	72827	1	Klebeschild	label	étiquette
			290	71410	1	Klebeschild	label	étiquette

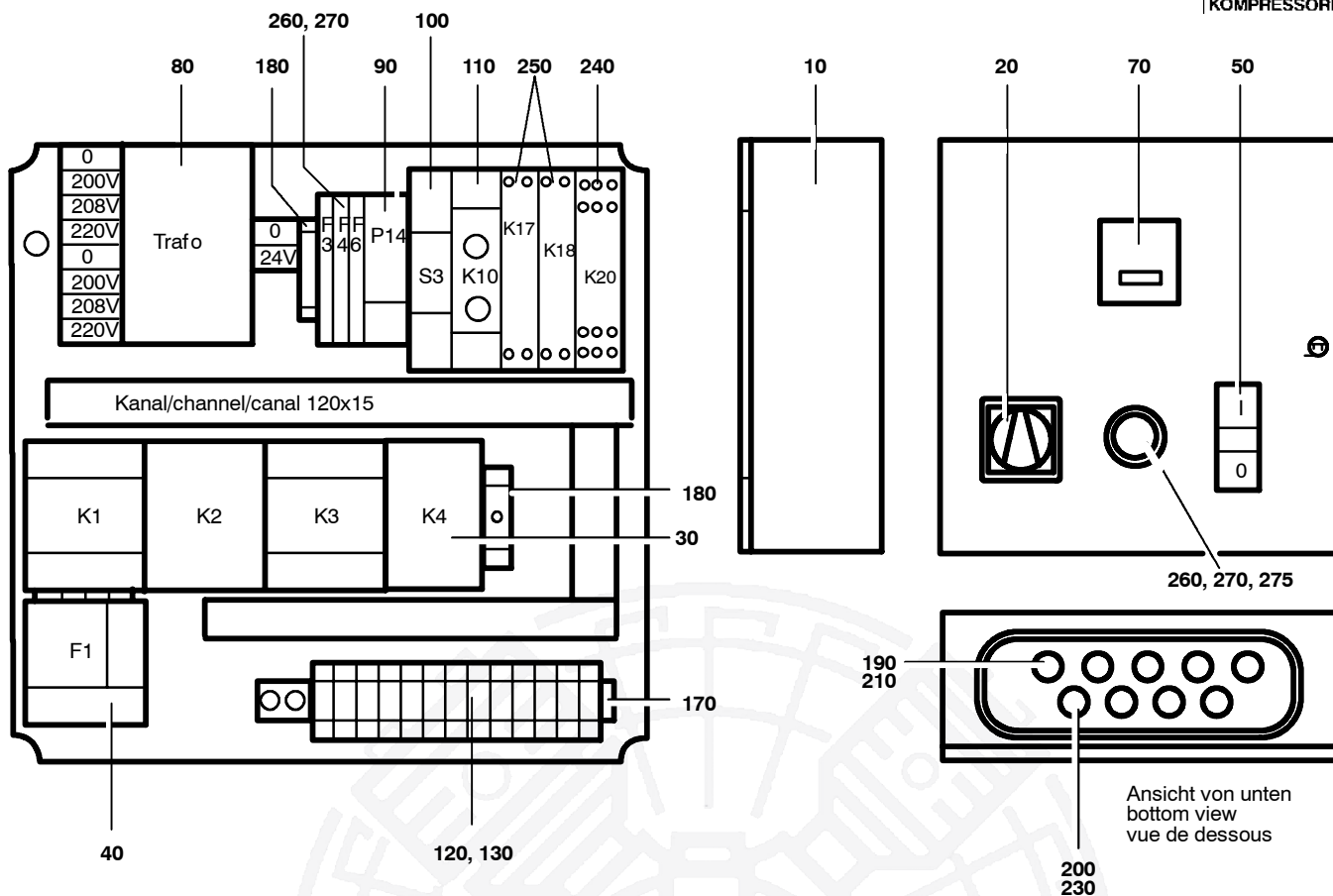

Ersatzteilsätze
 Spare parts sets
 Kits de pièces dét.

Baugruppe 79941 Kompressorsteuerung 4 kW; 380 - 440 V halbautomatisch
 Assembly 79941 Compressor control unit 4 kW; 380 - 440 V semi-automatic
 Assemblage 79941 Unité de commande 4 kW; 380 - 440 V semi-automatique

G50.4- 3

Klasse/ Class/ Classe			Pos.	Bestell-Nr. Part No. No. de cde.	Anz. Qty. Qté.	Benennung	Designation	Dénomination
a	b	c						
			10	N23779	1	Gehäuse	housing	boîtier
			20	N4555	1	Hauptschalter	main switch	interrupteur principal
			30	N26151	1	Stern-Dreieck-Kombination	star-delta contactor assy.	ensemble étoile-triangle
			40	N26152	1	Überlastrelais	overload relay	relais de surcharge
			50	N26308	1	Tastschalter kpl.	dual push-button switch	interrupteur
			70	N23853	1	Betriebsstundenzähler	hour meter 24VAC	compteur d'heures 24VAC
			80	N23791	1	Steuertransformator	control transformer	transformateur
			90	N19096	1	Summierzähler	cycle counter	compteur/totalisateur
			100	N16206	1	Installationsschalter	installation switch	interrupteur d'installation
			110	N16202	1	Taktgeber	timer	minuterie électrique
			120	N23685	16	Durchgangsklemme	terminal clamp	borne de phase
			130	N23688	2	Schutzleiterklemme	ground terminal	borne de terre
			140	N23689	1	Abschlußplatte	end plate	plaque de fermeture
			150	N23690	2	Endwinkel	end bracket	angle de fermeture
			160	N23778	7	Querverbindung	cross connection	connexion latérale
			170	N4863	mm	Tragschiene	bearing rail	rail support
			180	N16126	mm	Tragschiene	carrying rail	rail support
			190	N3100	3	Kabelverschraubung	cable stuffing box coupling	raccord presse-étoupe
			200	N3101	6	Kabelverschraubung	cable union	raccord de câble
			210	N3103	3	Gegenmutter	counternut	contre-écrou
			220	N3104	6	Gegenmutter	counternut	contre-écrou
			230	N22441	2	Schnittstellenrelais	intersection relay	relais d'interface
			240	N26439	1	Zeitrelais, Öldruck	time relay, oil pressure	relais, pression d'huile
			250	N26443	1	Frontelement	front element red oil symbol	élément de façade
			260	N26313	1	LED-Element	LED element	LED
			270	N26310	1	Befestigungsflansch	mounting bracket	bride de fixation
			280	N22351	1	Klebeschild	label	étiquette
			290	72827	1	Klebeschild	label	étiquette
			300	71410	1	Klebeschild	label	étiquette

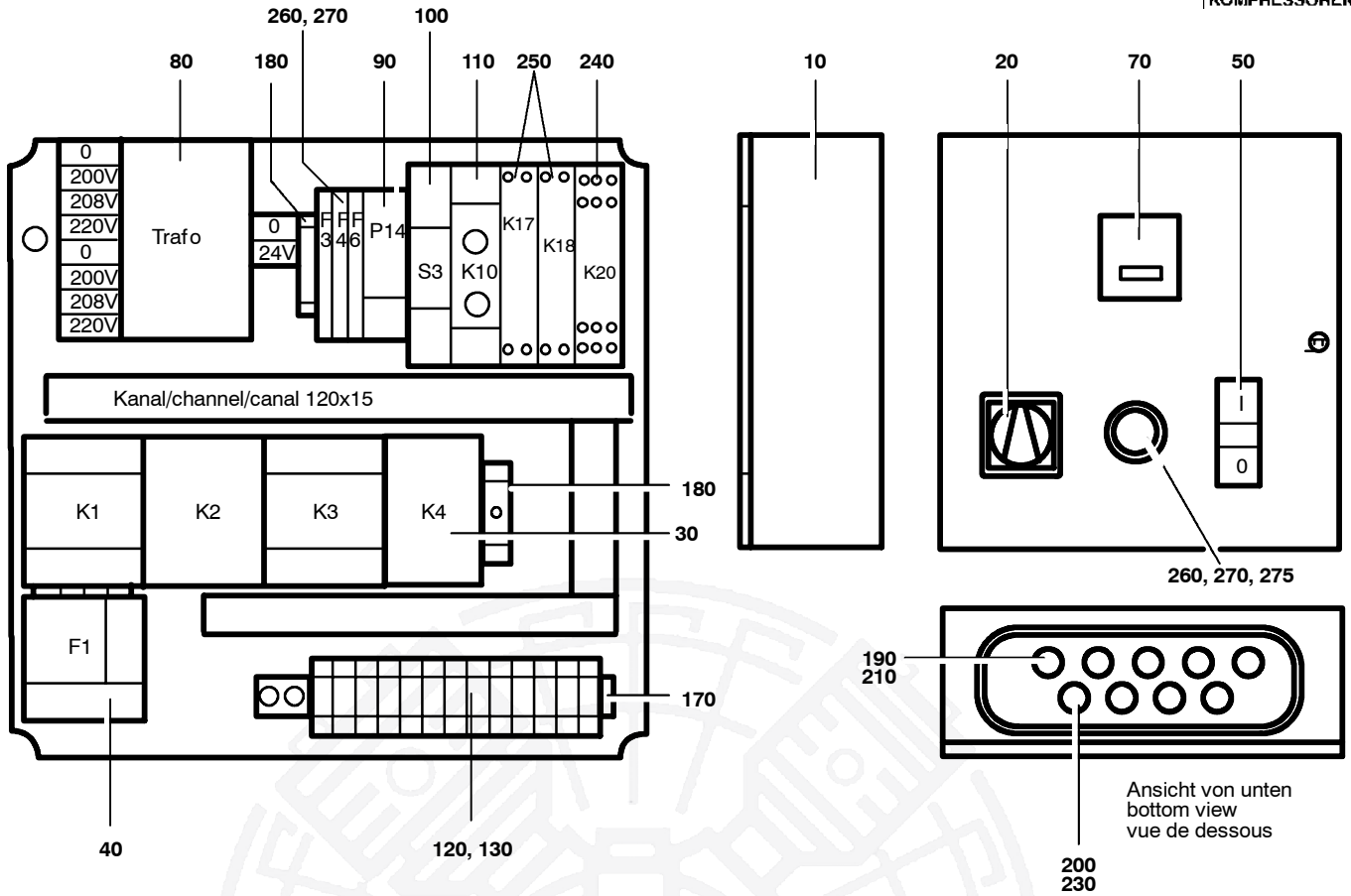

Ersatzteilsätze
Spare parts sets
Kits de pièces dét.

Baugruppe 79941
Assembly 79941
Assemblage 79941

Kompressorsteuerung 4 kW; 380 - 440 V halbautomatisch
Compressor control unit 4 kW; 380 - 440 V semi-automatic
Unité de commande 4 kW; 380 - 440 V semi-automatique

G50.4- 3

Klasse/ Class/ Classe			Pos.	Bestell-Nr. Part No. No. de cde.	Anz. Qty. Qté.	Benennung	Designation	Dénomination
a	b	c						
			--	N26437	1	Druckschalter, Oldruck	pressure switch, oil press.	electrovanne, press. h'huile
			--	N26438	1	Schutzkapp0e	protective cap	couvercle protecteur

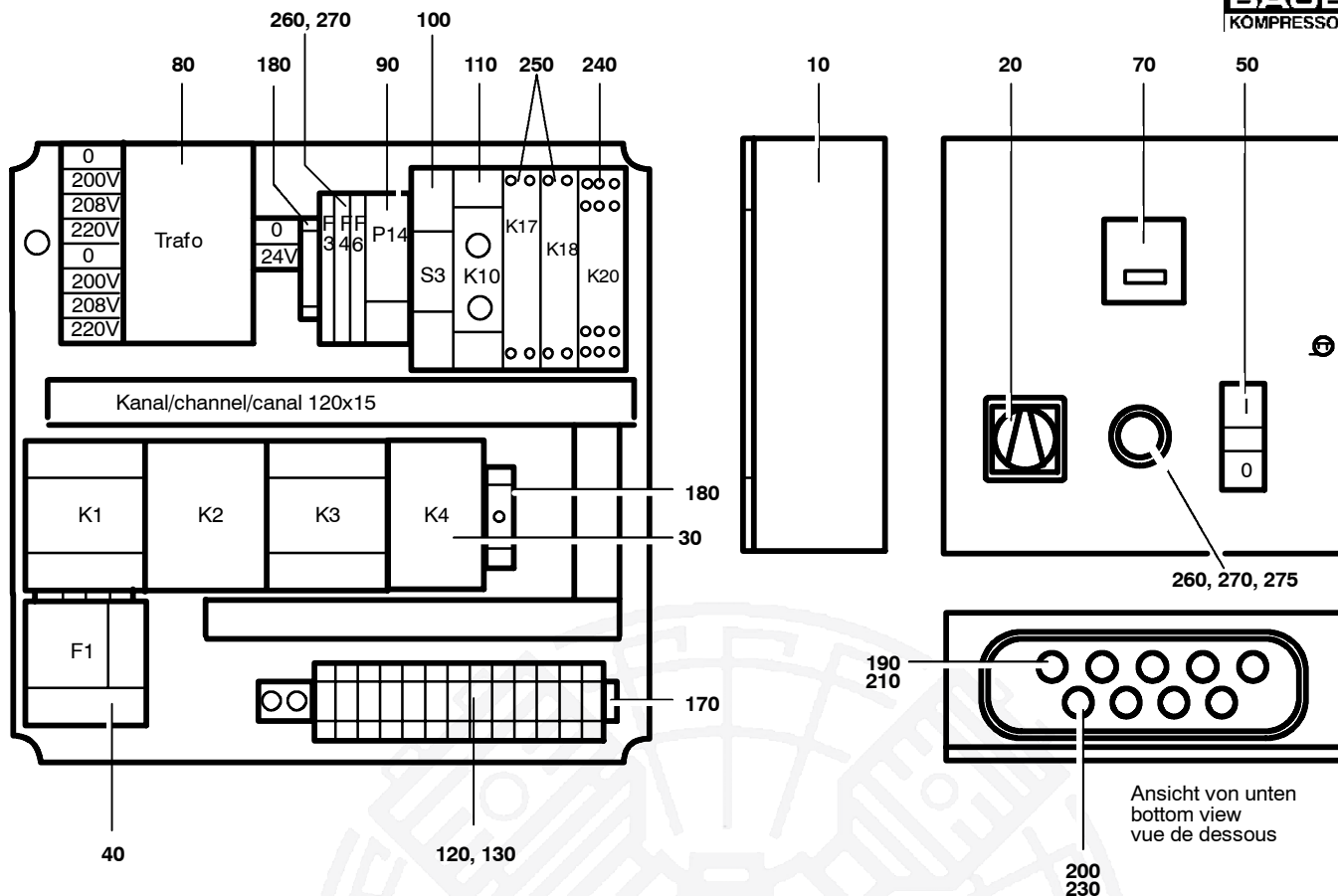



Ersatzteilsätze
 Spare parts sets
 Kits de pièces dét.

Baugruppe 79944 Kompressorsteuerung 4 kW; 380 - 440 V vollautomatisch
Assembley 79944 Compressor control unit 4 kW; 380 - 440 V automatic
Assemblage 79944 Unité de commande 4 kW; 380 - 440 V automatique

G50.4- 4

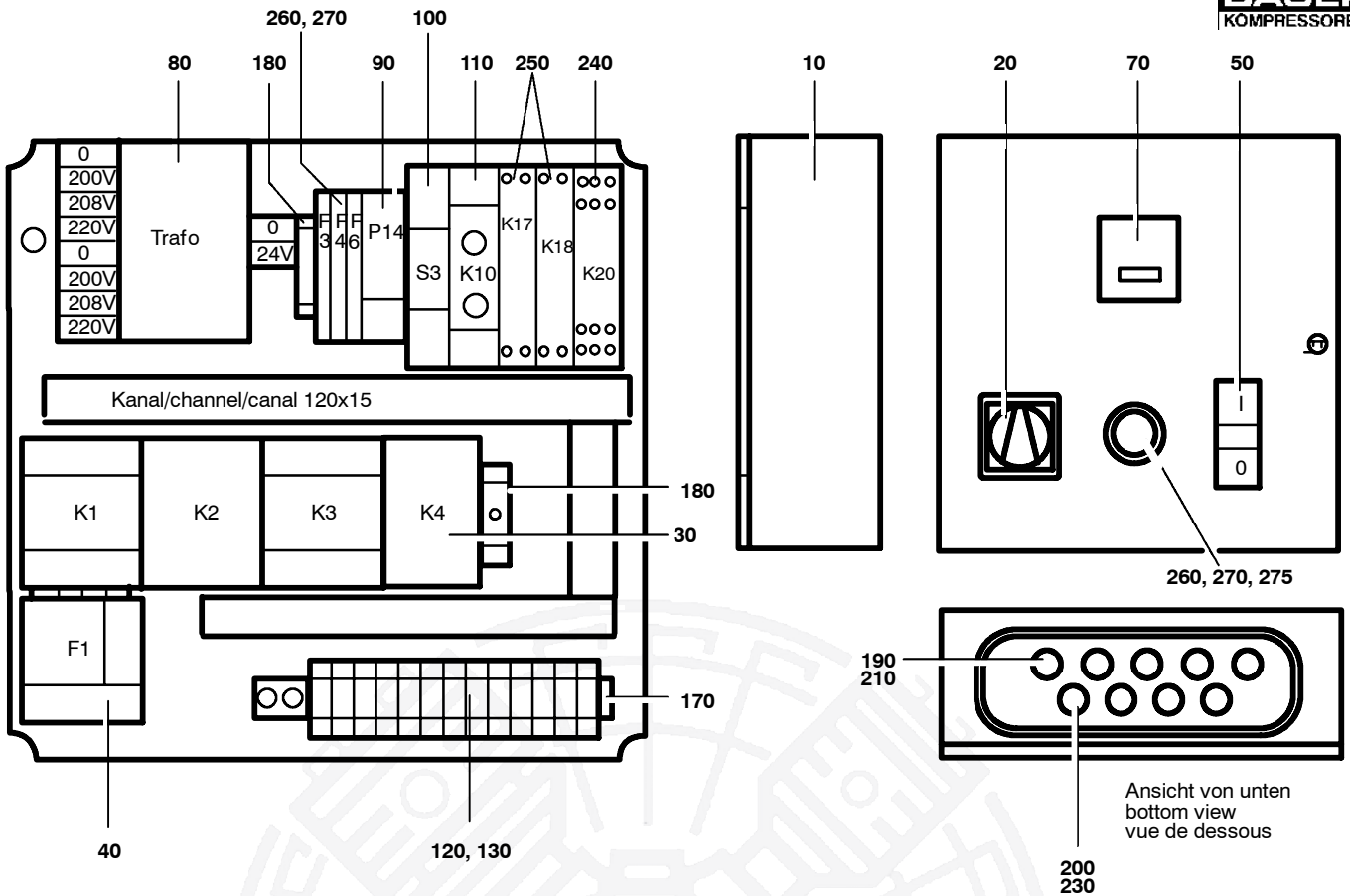
Klasse/ Class/ Classe			Pos.	Bestell-Nr. Part No. No. de cde.	Anz. Qty. Qté.	Benennung	Designation	Dénomination
a	b	c						
			10	N23779	1	Gehäuse	housing	boîtier
			20	N4555	1	Hauptschalter	main switch	interrupteur principal
			30	N26151	1	Stern-Dreieck-Kombination	star-delta contactor assy.	ensemble étoile-triangle
			40	N26152	1	Überlastrelais	overload relay	relais de surcharge
			50	N26308	1	Tastschalter kpl.	dual push-button switch	interrupteur
			70	N23853	1	Betriebsstundenzähler	hour meter 24VAC	compteur d'heures 24VAC
			80	N23791	1	Steuertransformator	control transformer	transformateur
			90	N19096	1	Summierzähler	cycle counter	compteur/totalisateur
			100	N16206	1	Installationsschalter	installation switch	interrupteur d'installation
			110	N26809	1	Taktgeber	timer	minuterie électrique
			120	N23685	16	Durchgangsklemme	terminal clamp	borne de phase
			130	N23688	2	Schutzleiterklemme	ground terminal	borne de terre
			140	N23689	1	Abschlußplatte	end plate	plaque de fermeture
			150	N23690	2	Endwinkel	end bracket	angle de fermeture
			160	N23778	7	Querverbindung	cross connection	connexion latérale
			170	N4863	mm	Tragschiene	bearing rail	rail support
			180	N16126	mm	Tragschiene	carrying rail	rail support
			190	N3100	3	Kabelverschraubung	cable stuffing box coupling	raccord presse-étoupe
			200	N3101	6	Kabelverschraubung	cable union	raccord de câble
			210	N3103	3	Gegenmutter	counternut	contre-écrou
			220	N3104	6	Gegenmutter	counternut	contre-écrou
			230	N22441	2	Schnittstellenrelais	intersection relay	relais d'interface
			240	N26439	1	Zeitrelais, Öldruck	time relay, oil pressure	relais, pression d'huile
			250	N26443	1	Frontelement	front element red oil symbol	élément de façade
			260	N26313	1	LED-Element	LED element	LED
			270	N26310	1	Befestigungsflansch	mounting bracket	bride de fixation
			280	N22351	1	Klebeschild	label	étiquette
			290	72827	1	Klebeschild	label	étiquette
			300	71410	1	Klebeschild	label	étiquette



G50.4- 5



Ersatzteilsätze
Spare parts sets
Kits de pièces dét.

Baugruppe 79942
Assembly 79942
Assemblage 79942

Kompressorsteuerung 5,5 kW; 380 - 440 V halbautomatisch
Compressor control unit 5,5 kW; 380 - 440 V semi-automatic
Unité de commande 5,5 kW; 380 - 440 V semi-automatique

Klasse/ Class/ Classe			Pos.	Bestell-Nr. Part No. No. de cde.	Anz. Qty. Qté.	Benennung	Designation	Dénomination
a	b	c						
			10	N23779	1	Gehäuse	housing	boîtier
			20	N4555	1	Hauptschalter	main switch	interrupteur principal
			30	N26151	1	Stern-Dreieck-Kombination	star-delta contactor assy.	ensemble étoile-triangle
			40	N26152	1	Überlastrelais	overload relay	relais de surcharge
			50	N26308	1	Tastschalter kpl.	dual push-button switch	interrupteur
			70	N23853	1	Betriebsstundenzähler	hour meter 24VAC	compteur d'heures 24VAC
			80	N23791	1	Steuertransformator	control transformer	transformateur
			90	N19096	1	Summierzähler	cycle counter	compteur/totalisateur
			100	N16206	1	Installationsschalter	installation switch	interrupteur d'installation
			110	N16202	1	Taktgeber	timer	minuterie électrique
			120	N23685	16	Durchgangsklemme	terminal clamp	borne de phase
			130	N23688	2	Schutzleiterklemme	ground terminal	borne de terre
			140	N23689	1	Abschlußplatte	end plate	plaque de fermeture
			150	N23690	2	Endwinkel	end bracket	angle de fermeture
			160	N23778	7	Querverbindung	cross connection	connexion latérale
			170	N4863	mm	Tragschiene	bearing rail	rail support
			180	N16126	mm	Tragschiene	carrying rail	rail support
			190	N3100	3	Kabelverschraubung	cable stuffing box coupling	raccord presse-étoupe
			200	N3101	6	Kabelverschraubung	cable union	raccord de câble
			210	N3103	3	Gegenmutter	counternut	contre-écrou
			220	N3104	6	Gegenmutter	counternut	contre-écrou
			230	N22441	2	Schnittstellenrelais	intersection relay	relais d'interface
			240	N26439	1	Zeitrelais, Öldruck	time relay, oil pressure	relais, pression d'huile
			250	N26443	1	Frontelement	front element red oil symbol	élément de façade
			260	N26313	1	LED-Element	LED element	LED
			270	N26310	1	Befestigungsflansch	mounting bracket	bride de fixation
			280	N22351	1	Klebeschild	label	étiquette
			290	72827	1	Klebeschild	label	étiquette
			300	71410	1	Klebeschild	label	étiquette

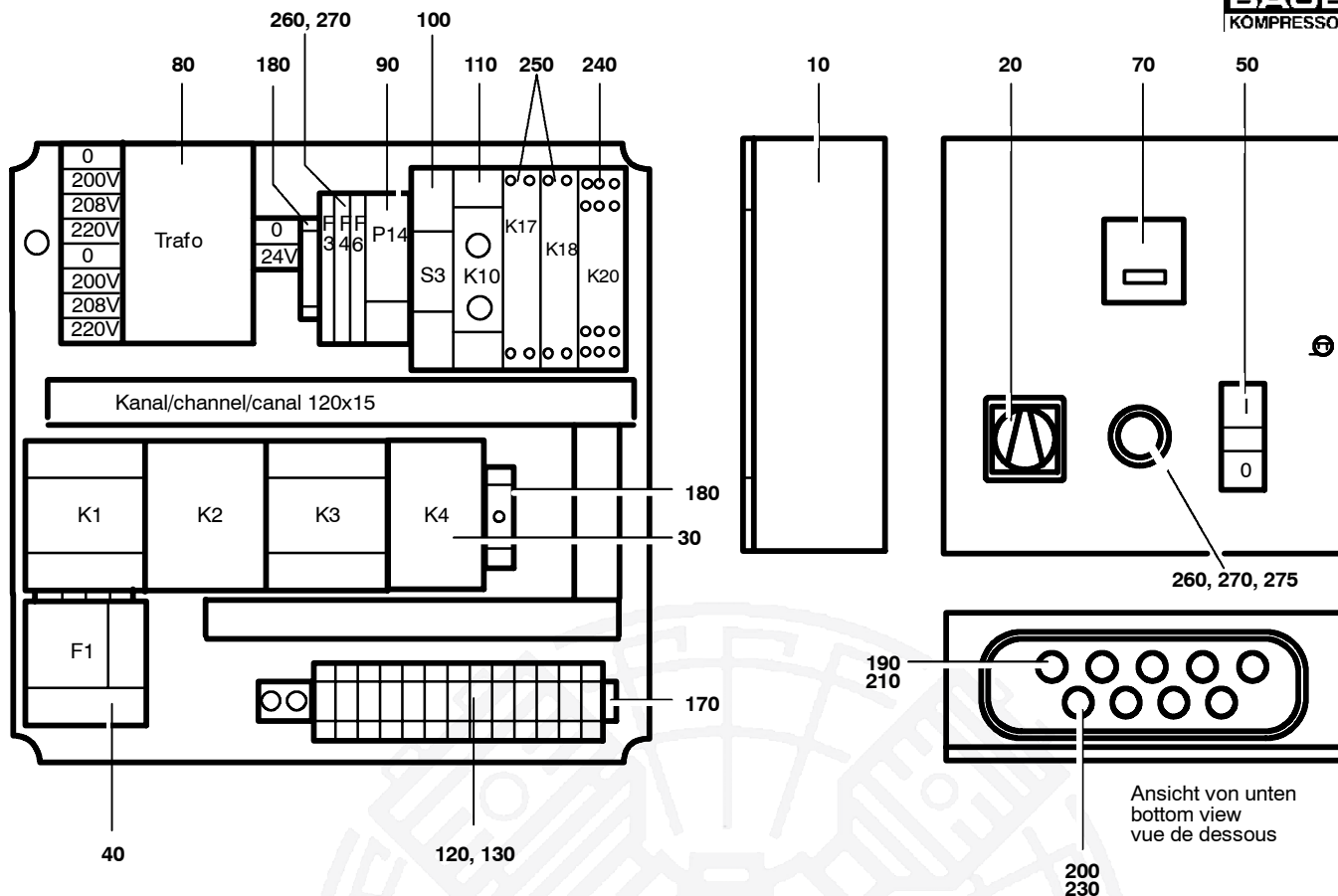

Ersatzteilsätze
Spare parts sets
Kits de pièces dét.

Baugruppe 79942 Kompressorsteuerung 5,5 kW; 380 - 440 V halbautomatisch
 Assembly 79942 Compressor control unit 5,5 kW; 380 - 440 V semi-automatic
 Assemblage 79942 Unité de commande 5,5 kW; 380 - 440 V semi-automatique

G50.4- 5

Klasse/ Class/ Classe			Pos.	Bestell-Nr. Part No. No. de cde.	Anz. Qty. Qté.	Benennung	Designation	Dénomination
a	b	c						
			--	N26437	1	Druckschalter, Oldruck	pressure switch, oil press.	electrovanne, press. h'huile
			--	N26438	1	Schutzkapp0e	protective cap	

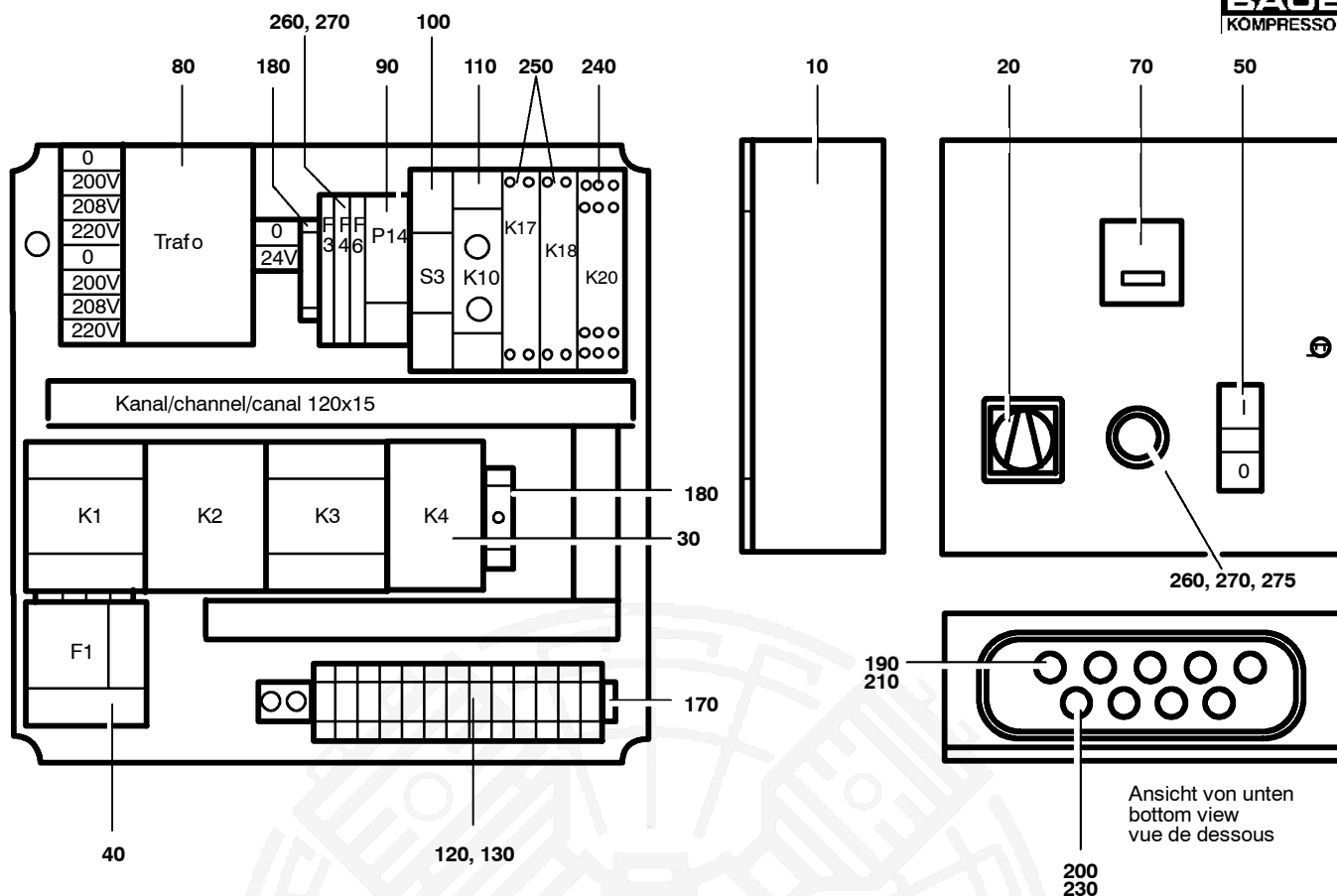

Ersatzteilsätze
 Spare parts sets
 Kits de pièces dét.

Baugruppe 79945
 Assembly 79945
 Assemblage 79945

Kompressorsteuerung 5,5 kW; 380 - 440 V vollautomatisch
 Compressor control unit 5,5 kW; 380 - 440 V automatic
 Unité de commande 5,5 kW; 380 - 440 V automatique

G50.4- 6

Klasse/ Class/ Classe			Pos.	Bestell-Nr. Part No. No. de cde.	Anz. Qty. Qté.	Benennung	Designation	Dénomination
a	b	c						
			10	N23779	1	Gehäuse	housing	boîtier
			20	N4555	1	Hauptschalter	main switch	interrupteur principal
			30	N26151	1	Stern-Dreieck-Kombination	star-delta contactor assy.	ensemble étoile-triangle
			40	N26152	1	Überlastrelais	overload relay	relais de surcharge
			50	N26308	1	Tastschalter kpl.	dual push-button switch	interrupteur
			70	N23853	1	Betriebsstundenzähler	hour meter 24VAC	compteur d'heures 24VAC
			80	N23791	1	Steuertransformator	control transformer	transformateur
			90	N19096	1	Summierzähler	cycle counter	compteur/totalisateur
			100	N16206	1	Installationsschalter	installation switch	interrupteur d'installation
			110	N26809	1	Taktgeber	timer	minuterie électrique
			120	N23685	16	Durchgangsklemme	terminal clamp	borne de phase
			130	N23688	2	Schutzleiterklemme	ground terminal	borne de terre
			140	N23689	1	Abschlußplatte	end plate	plaque de fermeture
			150	N23690	2	Endwinkel	end bracket	angle de fermeture
			160	N23778	7	Querverbindung	cross connection	connexion latérale
			170	N4863	mm	Tragschiene	bearing rail	rail support
			180	N16126	mm	Tragschiene	carrying rail	rail support
			190	N3100	3	Kabelverschraubung	cable stuffing box coupling	raccord presse-étoupe
			200	N3101	6	Kabelverschraubung	cable union	raccord de câble
			210	N3103	3	Gegenmutter	counternut	contre-écrou
			220	N3104	6	Gegenmutter	counternut	contre-écrou
			230	N22441	2	Schnittstellenrelais	intersection relay	relais d'interface
			240	N26439	1	Zeitrelais, Öldruck	time relay, oil pressure	relais, pression d'huile
			250	N26443	1	Frontelement	front element red oil symbol	élément de façade
			260	N26313	1	LED-Element	LED element	LED
			270	N26310	1	Befestigungsflansch	mounting bracket	bride de fixation
			280	N22351	1	Klebeschild	label	étiquette
			290	72827	1	Klebeschild	label	étiquette
			300	71410	1	Klebeschild	label	étiquette

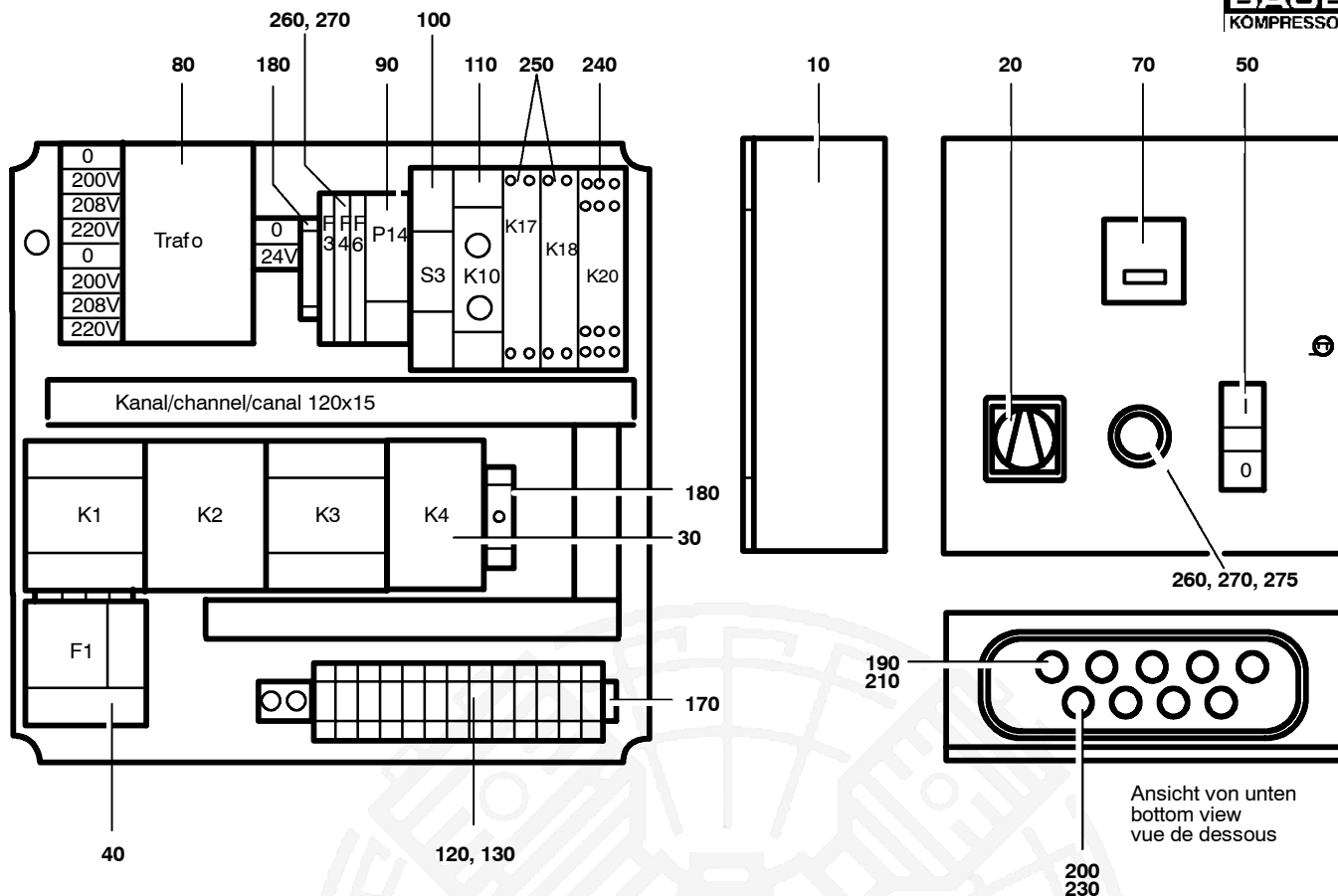

Ersatzteilsätze
 Spare parts sets
 Kits de pièces dét.

Baugruppe 80488 Kompressorsteuerung 3 kW; 220 - 240 V halbautomatisch
 Assembly 80488 Compressor control unit 3 kW; 220 - 240 V semi-automatic
 Assemblage 80488 Unité de commande 3 kW; 220 - 240 V semi-automatique

G50.4-7

Klasse/ Class/ Classe			Pos.	Bestell-Nr. Part No. No. de cde.	Anz. Qty. Qté.	Benennung	Designation	Dénomination
a	b	c						
			10	N23779	1	Gehäuse	housing	boîtier
			20	N4555	1	Hauptschalter	main switch	interrupteur principal
			30	N26156	1	Motorschütz	motor contactor	disjoncteur moteur
			40	N26037	1	Überlastrelais	overload relay	relais de surcharge
			50	N26308	1	Tastschalter kpl.	dual push-button switch	interrupteur
			70	N23853	1	Betriebsstundenzähler	hour meter	compteur d'heures
			80	N23791	1	Steuertransformator	control transformer	transformateur
			90	N19096	1	Summierzähler	cycle counter	compteur/totalisateur
			100	N16206	1	Installationsschalter	installation switch	interrupteur d'installation
			110	N16202	1	Taktgeber	timer	minuterie électrique
			120	N23685	16	Durchgangsklemme	terminal clamp	borne de phase
			130	N23688	2	Schutzleiterklemme	ground terminal	borne de terre
			140	N23689	1	Abschlußplatte	end plate	plaque de fermeture
			150	N23690	2	Endwinkel	end bracket	angle de fermeture
			160	N23778	7	Querverbindung	cross connection	connexion latérale
			170	N4863	mm	Tragschiene	bearing rail	rail support
			180	N16126	mm	Tragschiene	carrying rail	rail support
			190	N3100	3	Kabelverschraubung	cable stuffing box coupling	raccord presse-étoupe
			200	N3101	6	Kabelverschraubung	cable union	raccord de câble
			210	N3103	3	Gegenmutter	counternut	contre-écrou
			230	N3104	6	Gegenmutter	counternut	contre-écrou
			240	N26439	1	Zeitrelais, Öldruck	time relay, oil pressure	relais, pression d'huile
			250	N22441	2	Schnittstellenrelais	intersection relay	relais d'interface
			260	N26443	1	Frontelement	front element red oil symbol	élément de façade
			270	N26313	1	LED-Element	LED element	LED
			275	N26310	1	Befestigungsflansch	mounting bracket	bride de fixation
			290	72827	1	Klebeschild	label	étiquette
			300	71410	1	Klebeschild	label	étiquette
			310	N22351	1	Klebeschild	label	étiquette

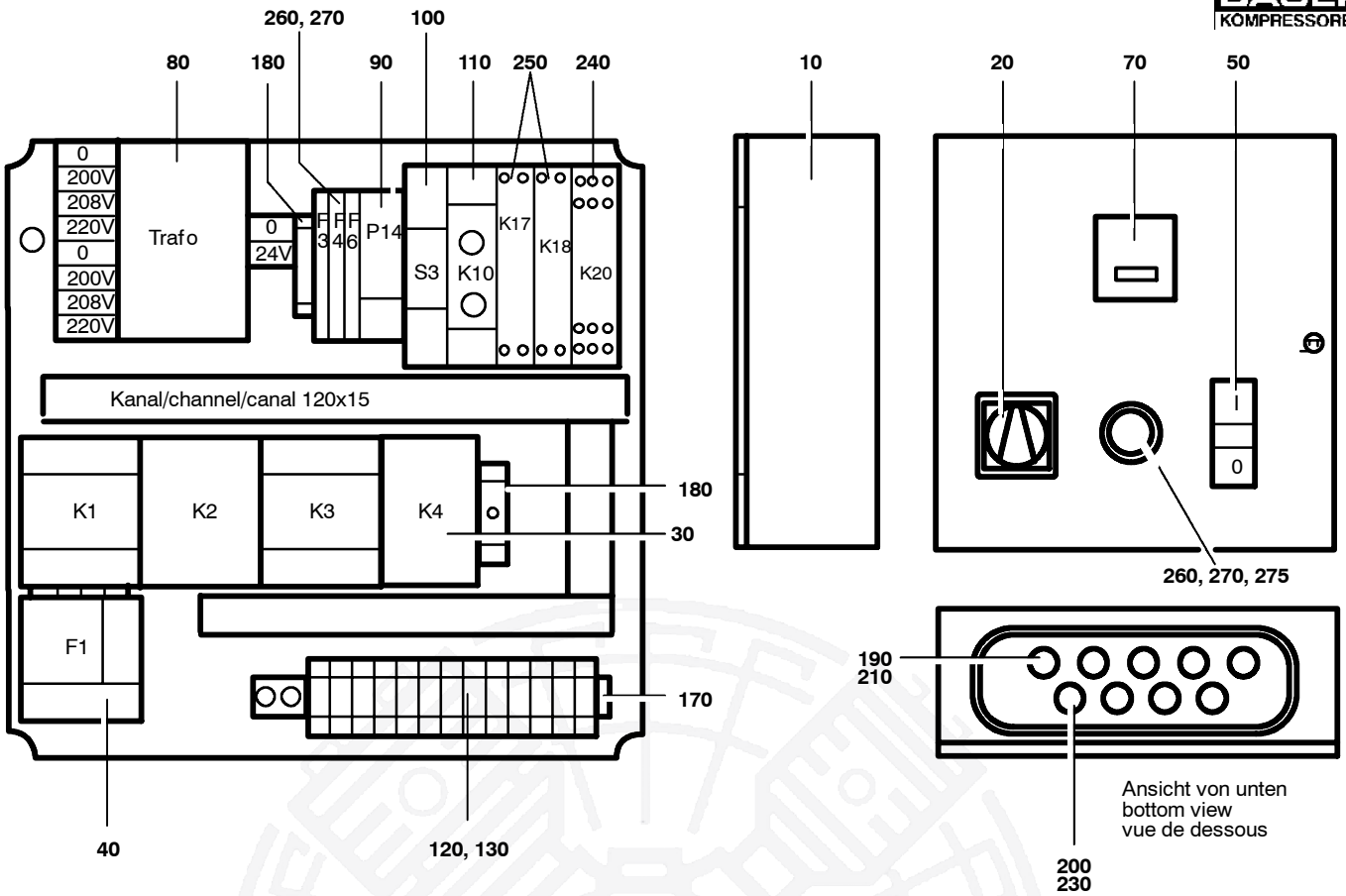

Ersatzteilsätze
Spare parts sets
Kits de pièces dét.

Baugruppe 80488
Assembly 80488
Assemblage 80488

Kompressorsteuerung 3 kW; 220 - 240 V halbautomatisch
Compressor control unit 3 kW; 220 - 240 V semi-automatic
Unité de commande 3 kW; 220 - 240 V semi-automatique

G50.4- 7

Klasse/ Class/ Classe			Pos.	Bestell-Nr. Part No. No. de cde.	Anz. Qty. Qté.	Benennung	Designation	Dénomination
a	b	c						
			--	N26437	1	Druckschalter, Oldruck	pressure switch, oil press.	electrovanne, press. h'huile
			--	N26438	1	Schutzkapp0e	protective cap	

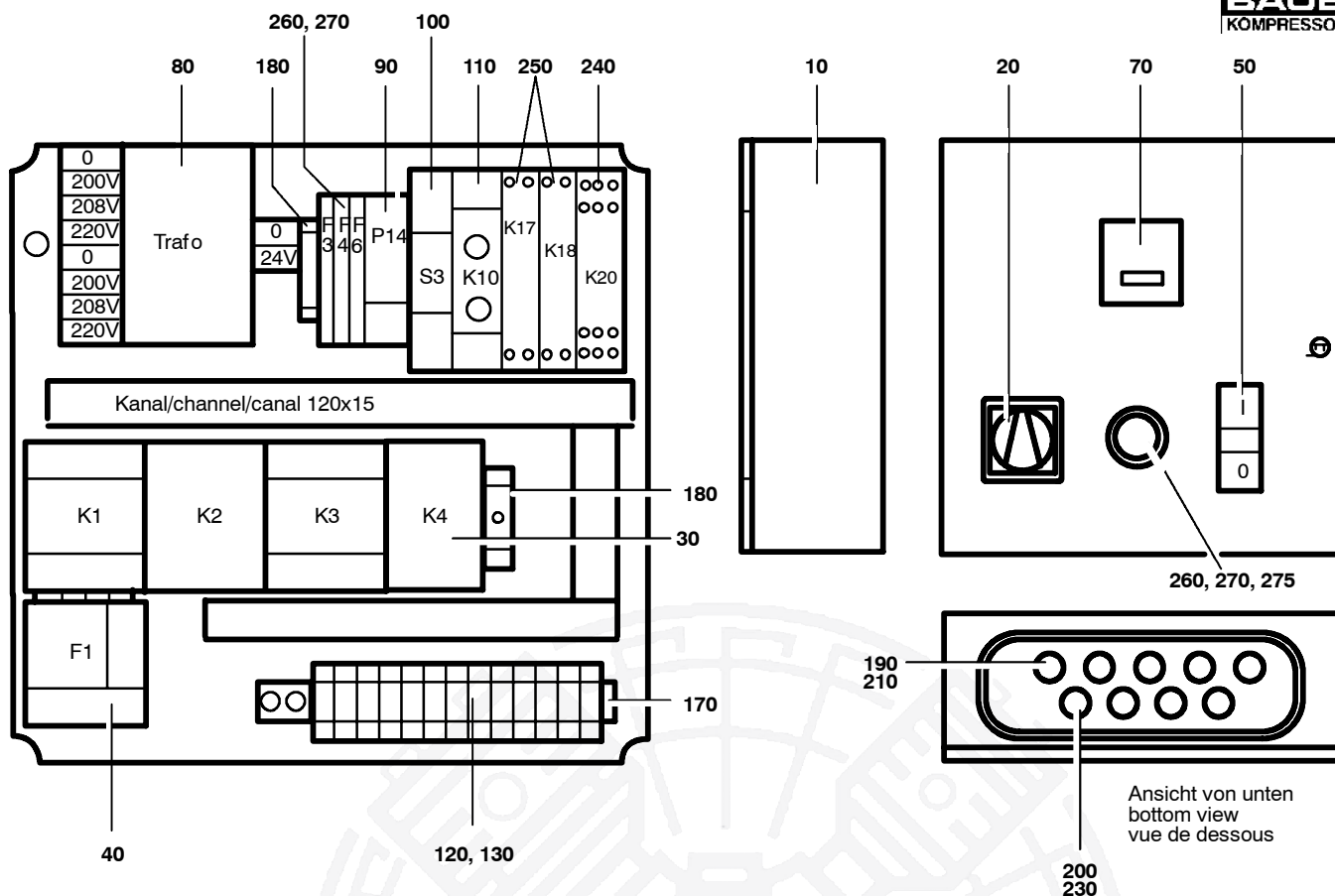



 Ersatzteilsätze
 Spare parts sets
 Kits de pièces dét.

Baugruppe 80491 Kompressorsteuerung 3 kW; 220 - 240 V vollautomatisch
 Assembly 80491 Compressor control unit 3 kW; 220 - 240 V automatic
 Assemblage 80491 Unité de commande 3 kW; 220 - 240 V automatique

G50.4- 8

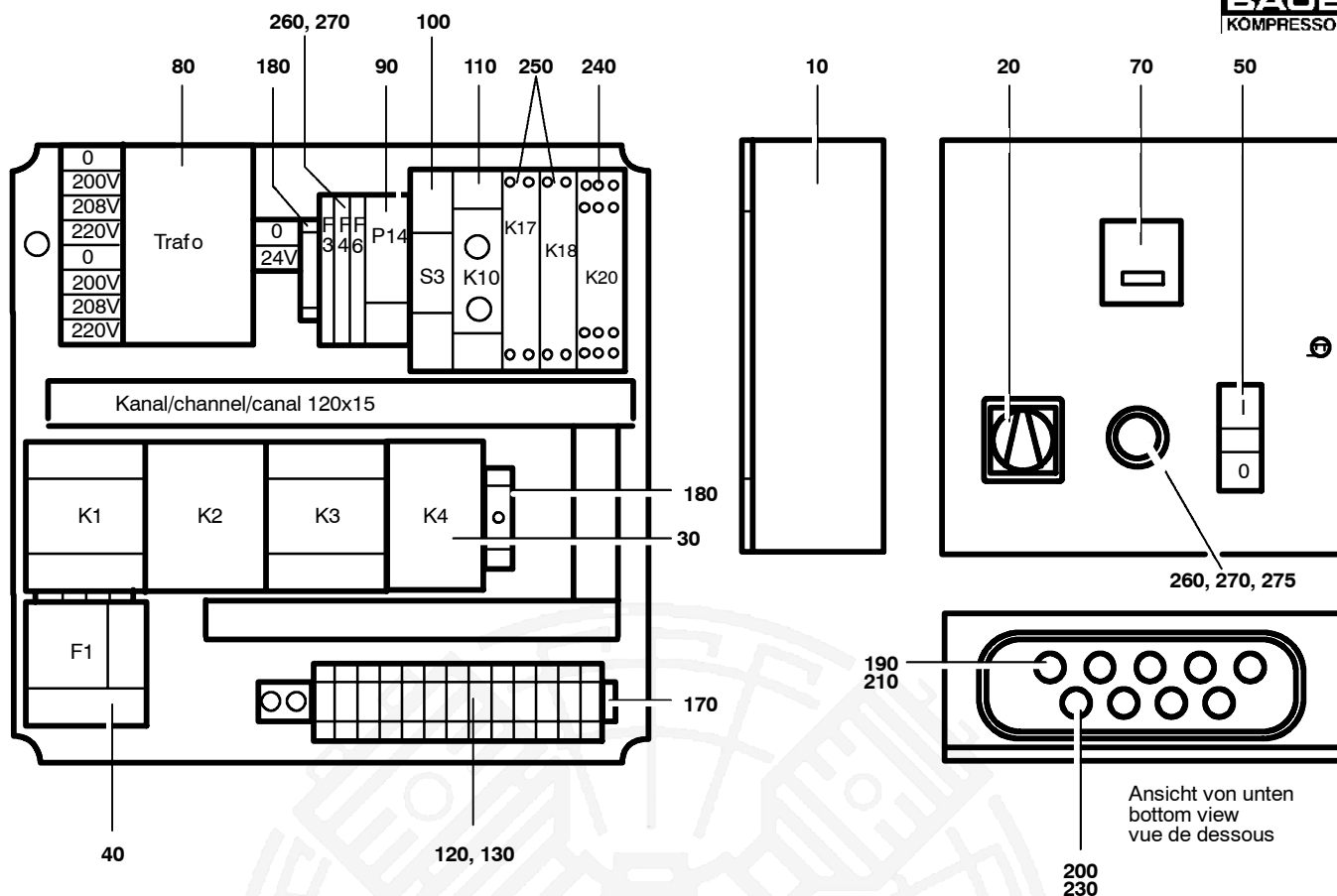
Klasse/ Class/ Classe			Pos.	Bestell-Nr. Part No. No. de cde.	Anz. Qty. Qté.	Benennung	Designation	Dénomination
a	b	c						
			10	N23779	1	Gehäuse	housing	boîtier
			20	N4555	1	Hauptschalter	main switch	interrupteur principal
			30	N26156	1	Motorschütz	motor contactor	disjoncteur moteur
			40	N26037	1	Überlastrelais	overload relay	relais de surcharge
			50	N26308	1	Tastschalter kpl.	dual push-button switch	interrupteur
			70	N23853	1	Betriebsstundenzähler	hour meter	compteur d'heures
			80	N23791	1	Steuertransformator	control transformer	transformateur
			90	N19096	1	Zyklenzähler	cycle counter	compteur/totalisateur
			100	N16206	1	Installationsschalter	installation switch	interrupteur d'installation
			110	N26809	1	Taktgeber	timer	minuterie électrique
			120	N23685	16	Durchgangsklemme	terminal clamp	borne de phase
			130	N23688	2	Schutzleiterklemme	ground terminal	borne de terre
			140	N23689	1	Abschlußplatte	end plate	plaque de fermeture
			150	N23690	2	Endwinkel	end bracket	angle de fermeture
			160	N23778	7	Querverbindung	cross connection	connexion latérale
			170	N4863	mm	Tragschiene	bearing rail	rail support
			180	N16126	mm	Tragschiene	carrying rail	rail support
			190	N3100	3	Kabelverschraubung	cable stuffing box coupling	raccord presse-étoupe
			200	N3101	6	Kabelverschraubung	cable union	raccord de câble
			210	N3103	3	Gegenmutter	counternut	contre-écrou
			220	N3104	6	Gegenmutter	counternut	contre-écrou
			230	N22441	2	Schnittstellenrelais	intersection relay	relais d'interface
			240	N26439	1	Zeitrelais, Öldruck	time relay, oil pressure	relais, pression d'huile
			250	N26443	1	Frontelement	front element red oil symbol	élément de façade
			260	N26313	1	LED-Element	LED element	LED
			270	N26310	1	Befestigungsflansch	mounting bracket	bride de fixation
			280	N22351	1	Klebeschild	label	étiquette
			290	72827	1	Klebeschild	label	étiquette
			290	71410	1	Klebeschild	label	étiquette



Ersatzteilsätze
 Spare parts sets
 Kits de pièces dét.

Baugruppe 79943 Kompressorsteuerung 4 kW; 220 - 240 V halbautomatisch
Assembly 79943 Compressor control unit 4 kW; 220 - 240 V semi-automatic
Assemblage 79943 Unité de commande 4 kW; 220 - 240 V semi-automatique

G50.4- 9

Klasse/ Class/ Classe			Pos.	Bestell-Nr. Part No. No. de cde.	Anz. Qty. Qté.	Benennung	Designation	Dénomination
a	b	c						
			10	N23779	1	Gehäuse	housing	boîtier
			20	N4555	1	Hauptschalter	main switch	interrupteur principal
			30	N26151	1	Stern-Dreieck-Kombination	star-delta contactor assy.	ensemble étoile-triangle
			40	N26153	1	Überlastrelais	overload relay	relais de surcharge
			50	N26308	1	Tastschalter kpl.	dual push-button switch	interrupteur
			70	N23853	1	Betriebsstundenzähler	hour meter 24VAC	compteur d'heures 24VAC
			80	N23791	1	Steuertransformator	control transformer	transformateur
			90	N19096	1	Summierzähler	cycle counter	compteur/totalisateur
			100	N16206	1	Installationsschalter	installation switch	interrupteur d'installation
			110	N16202	1	Taktgeber	timer	minuterie électrique
			120	N23685	16	Durchgangsklemme	terminal clamp	borne de phase
			130	N23688	2	Schutzleiterklemme	ground terminal	borne de terre
			140	N23689	1	Abschlußplatte	end plate	plaque de fermeture
			150	N23690	2	Endwinkel	end bracket	angle de fermeture
			160	N23778	7	Querverbindung	cross connection	connexion latérale
			170	N4863	mm	Tragschiene	bearing rail	rail support
			180	N16126	mm	Tragschiene	carrying rail	rail support
			190	N3100	3	Kabelverschraubung	cable stuffing box coupling	raccord presse-étoupe
			200	N3101	6	Kabelverschraubung	cable union	raccord de câble
			210	N3103	3	Gegenmutter	counternut	contre-écrou
			220	N3104	6	Gegenmutter	counternut	contre-écrou
			230	N22441	2	Schnittstellenrelais	intersection relay	relais d'interface
			240	N26439	1	Zeitrelais, Öldruck	time relay, oil pressure	relais, pression d'huile
			250	N26443	1	Frontelement	front element red oil symbol	élément de façade
			260	N26313	1	LED-Element	LED element	LED
			270	N26310	1	Befestigungsflansch	mounting bracket	bride de fixation
			280	N22351	1	Klebeschild	label	étiquette
			290	72827	1	Klebeschild	label	étiquette
			300	71410	1	Klebeschild	label	étiquette

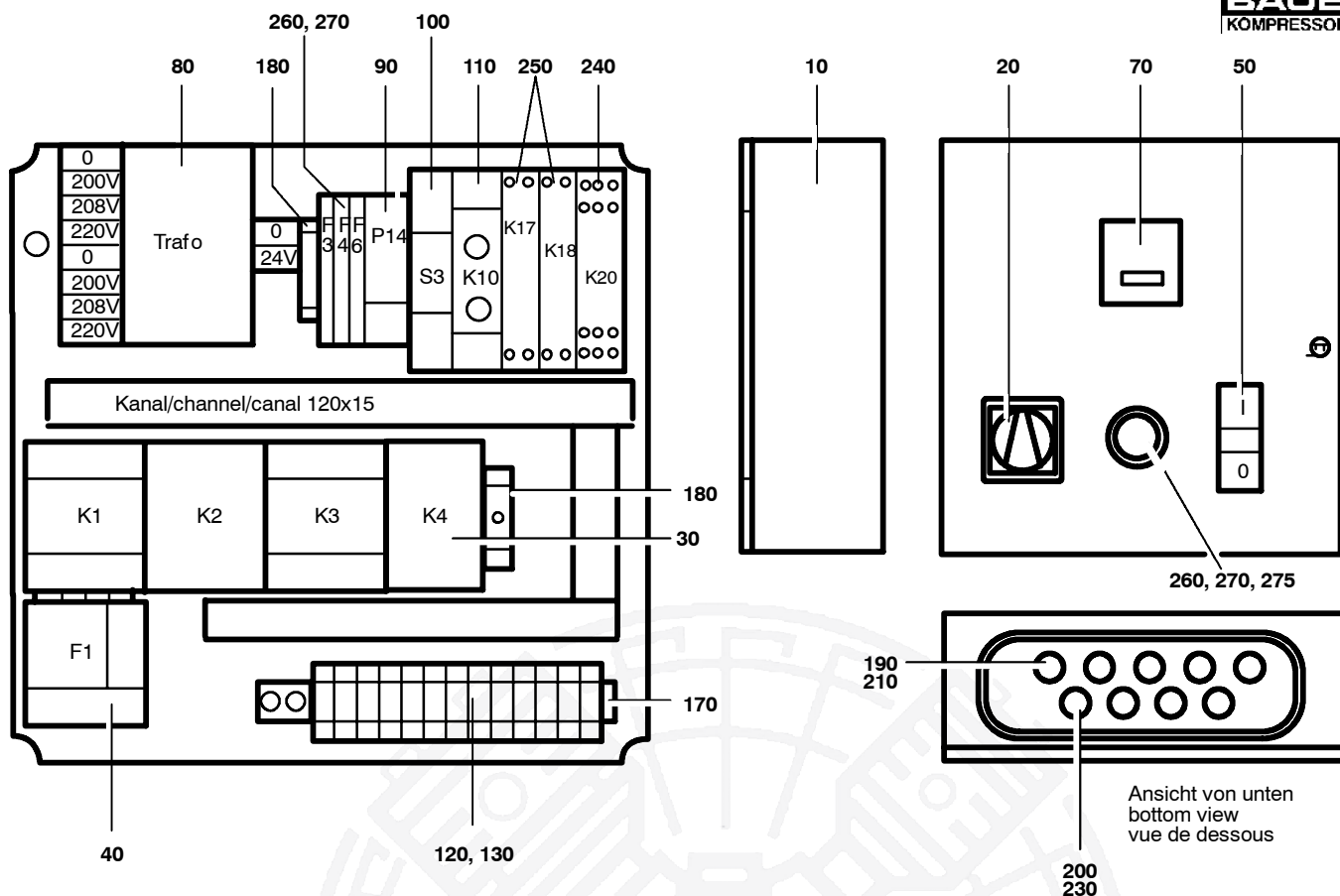

Ersatzteilsätze
Spare parts sets
Kits de pièces dét.

Baugruppe 79943 Kompressorsteuerung 4 kW; 220 - 240 V halbautomatisch
 Assembly 79943 Compressor control unit 4 kW; 220 - 240 V semi-automatic
 Assemblage 79943 Unité de commande 4 kW; 220 - 240 V semi-automatique

G50.4- 9

Klasse/ Class/ Classe			Pos.	Bestell-Nr. Part No. No. de cde.	Anz. Qty. Qté.	Benennung	Designation	Dénomination
a	b	c						
			--	N26437	1	Druckschalter, Oldruck	pressure switch, oil press.	electrovanne, press. h'huile
			--	N26438	1	Schutzkapp0e	protective cap	

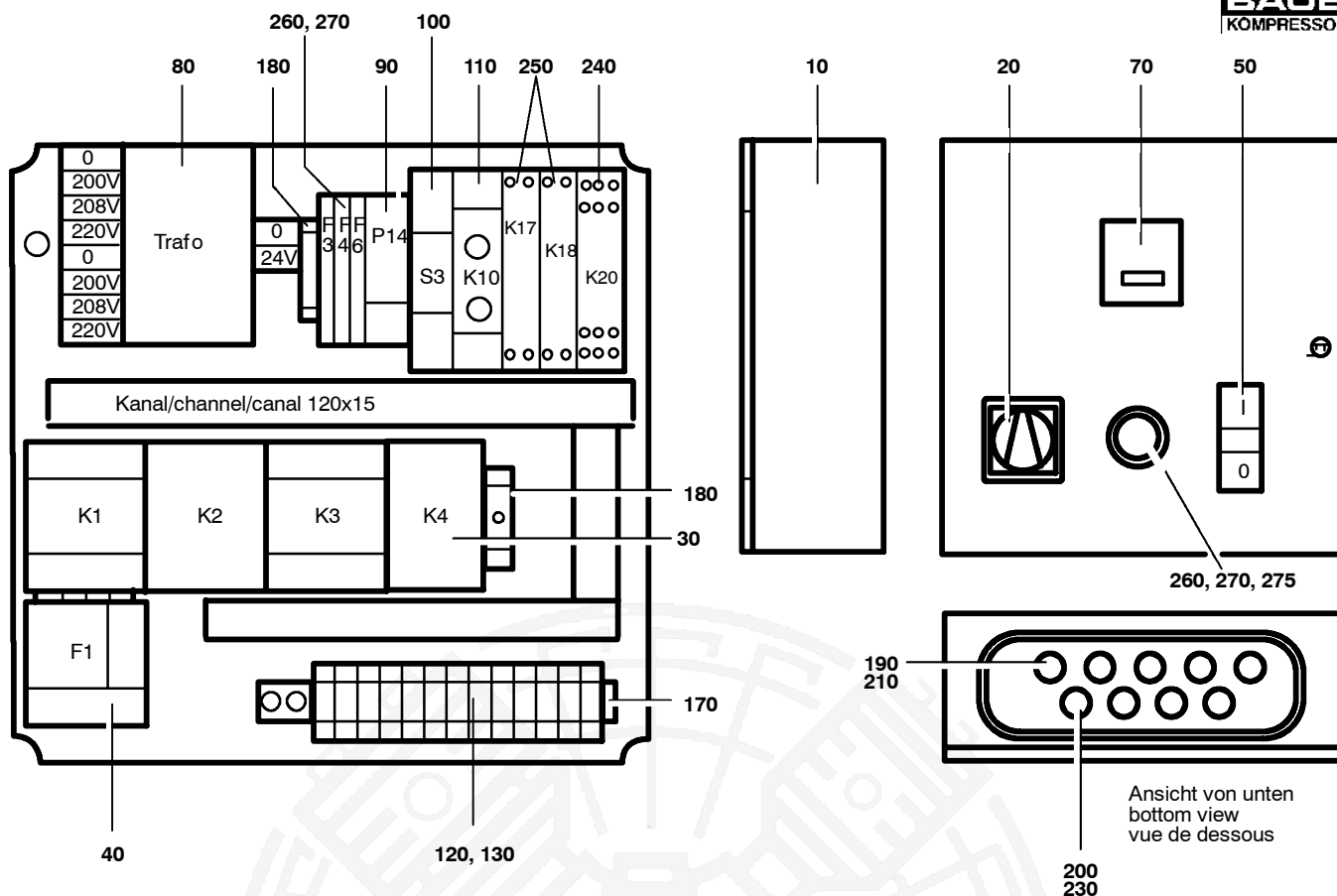



Ersatzteilsätze
 Spare parts sets
 Kits de pièces dét.

Baugruppe 79951 Kompressorsteuerung 4 kW; 220 - 240 V vollautomatisch
 Assembly 79951 Compressor control unit 4 kW; 220 - 240 V automatic
 Assemblage 79951 Unité de commande 4 kW; 220 - 240 V automatique

G50.4- 10

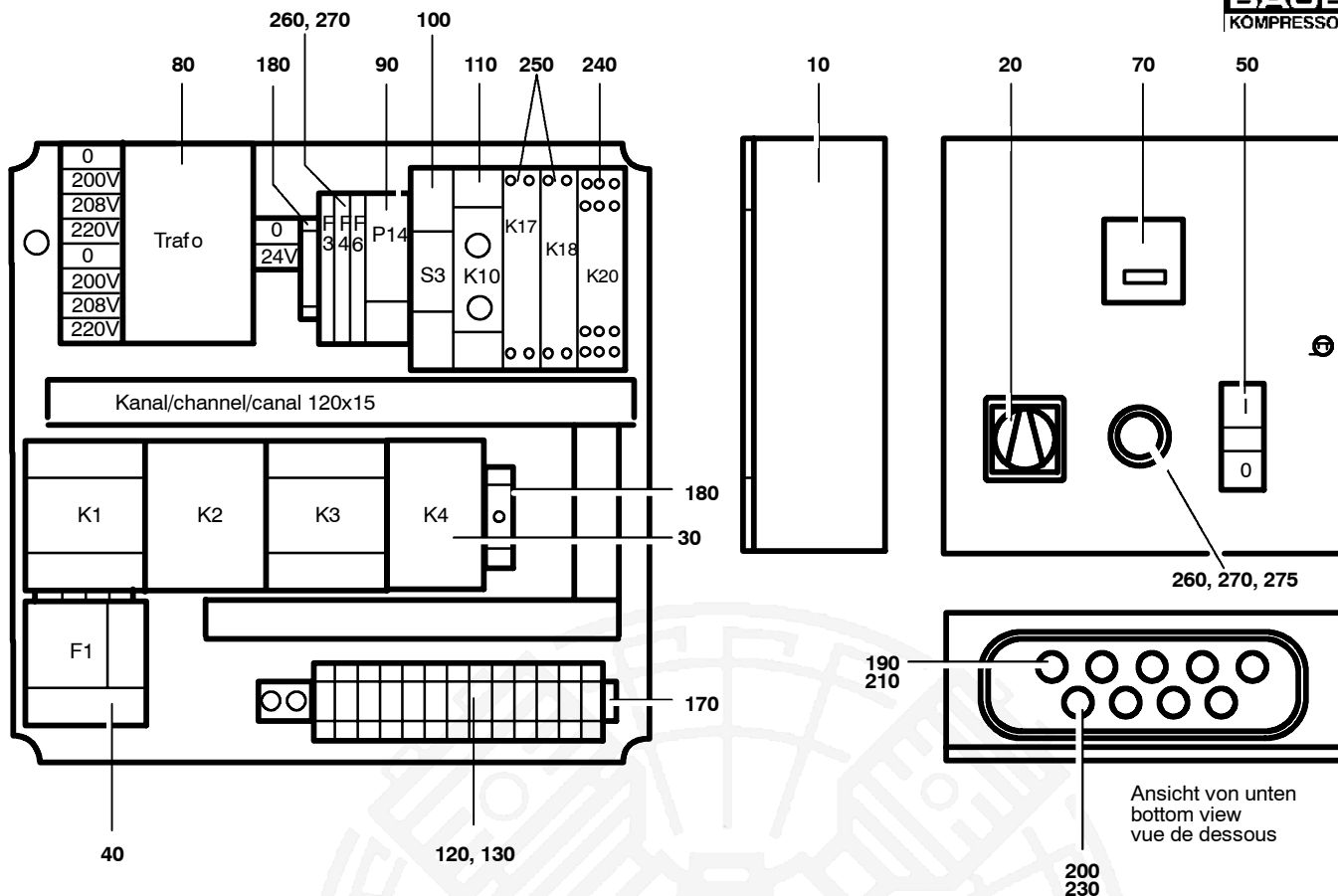
Klasse/ Class/ Classe			Pos.	Bestell-Nr. Part No. No. de cde.	Anz. Qty. Qté.	Benennung	Designation	Dénomination
a	b	c						
			10	N23779	1	Gehäuse	housing	boîtier
			20	N4555	1	Hauptschalter	main switch	interrupteur principal
			30	N26151	1	Stern-Dreieck-Kombination	star-delta contactor assy.	ensemble étoile-triangle
			40	N26153	1	Überlastrelais	overload relay	relais de surcharge
			50	N26308	1	Tastschalter kpl.	dual push-button switch	interrupteur
			70	N23853	1	Betriebsstundenzähler	hour meter 24VAC	compteur d'heures 24VAC
			80	N23791	1	Steuertransformator	control transformer	transformateur
			90	N19096	1	Summierzähler	cycle counter	compteur/totalisateur
			100	N16206	1	Installationsschalter	installation switch	interrupteur d'installation
			110	N26809	1	Taktgeber	timer	minuterie électrique
			120	N23685	16	Durchgangsklemme	terminal clamp	borne de phase
			130	N23688	2	Schutzleiterklemme	ground terminal	borne de terre
			140	N23689	1	Abschlußplatte	end plate	plaque de fermeture
			150	N23690	2	Endwinkel	end bracket	angle de fermeture
			160	N23778	7	Querverbindung	cross connection	connexion latérale
			170	N4863	mm	Tragschiene	bearing rail	rail support
			180	N16126	mm	Tragschiene	carrying rail	rail support
			190	N3100	3	Kabelverschraubung	cable stuffing box coupling	raccord presse-étoupe
			200	N3101	6	Kabelverschraubung	cable union	raccord de câble
			210	N3103	3	Gegenmutter	counternut	contre-écrou
			220	N3104	6	Gegenmutter	counternut	contre-écrou
			230	N22441	2	Schnittstellenrelais	intersection relay	relais d'interface
			240	N26439	1	Zeitrelais, Öldruck	time relay, oil pressure	relais, pression d'huile
			250	N26443	1	Frontelement	front element red oil symbol	élément de façade
			260	N26313	1	LED-Element	LED element	LED
			270	N26310	1	Befestigungsflansch	mounting bracket	bride de fixation
			280	N22351	1	Klebeschild	label	étiquette
			290	72827	1	Klebeschild	label	étiquette
			300	71410	1	Klebeschild	label	étiquette





Ersatzteilsätze
 Spare parts sets
 Kits de pièces dét.

Baugruppe 80487 Kompressorsteuerung 5,5 kW; 220 - 240 V halbautomatisch
Assembly 80487 Compressor control unit 5,5 kW; 220 - 240 V semi-automatic
Assemblage 80487 Unité de commande 5,5 kW; 220 - 240 V semi-automatique

G50.4- 11

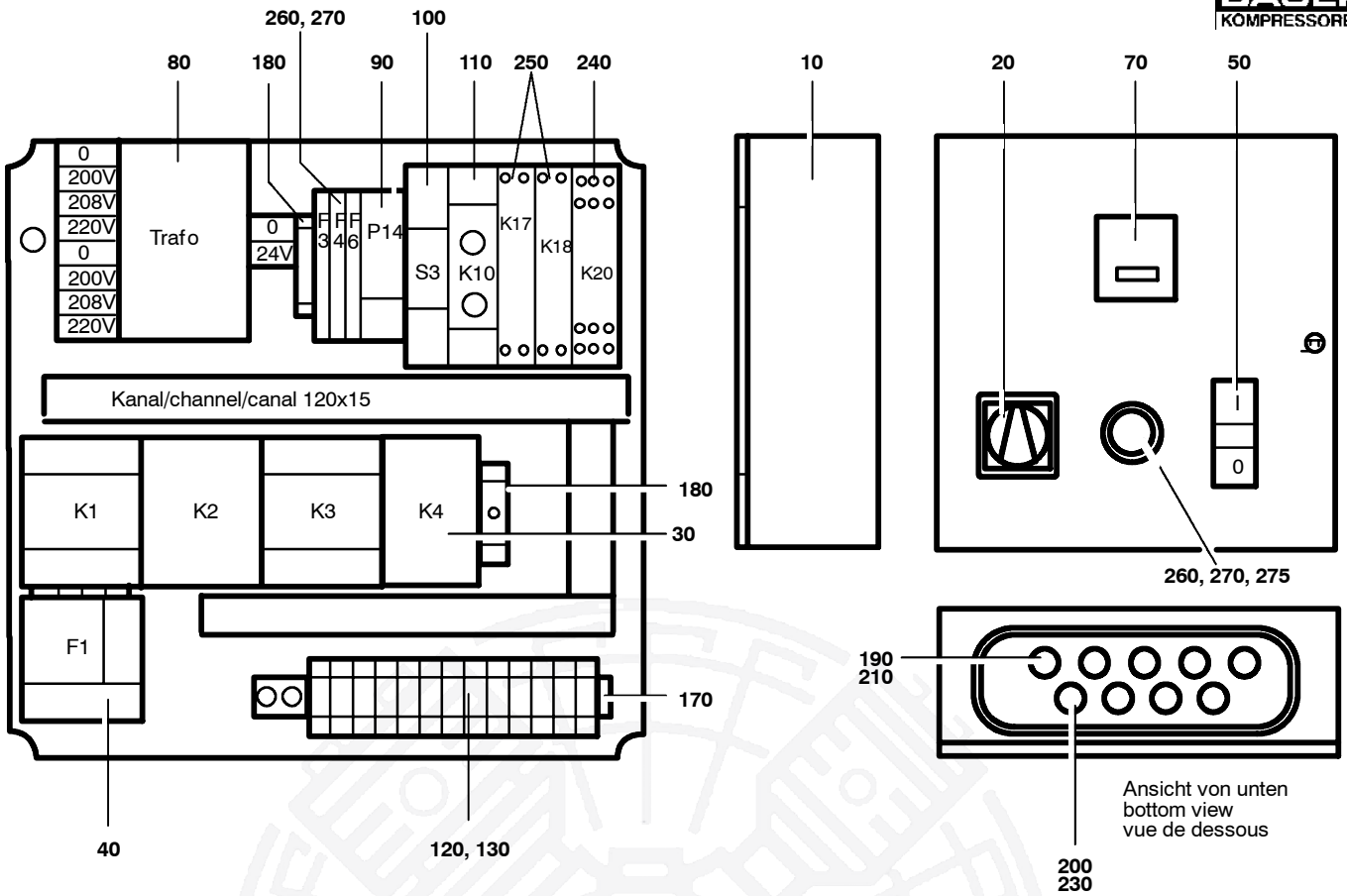
Klasse/ Class/ Classe			Pos.	Bestell-Nr. Part No. No. de cde.	Anz. Qty. Qté.	Benennung	Designation	Dénomination
a	b	c						
			10	N23779	1	Gehäuse	housing	boîtier
			20	N4555	1	Hauptschalter	main switch	interrupteur principal
			30	N26151	1	Stern-Dreieck-Kombination	star-delta contactor assy.	ensemble étoile-triangle
			40	N26037	1	Überlastrelais	overload relay	relais de surcharge
			50	N26308	1	Tastschalter kpl.	dual push-button switch	interrupteur
			70	N23853	1	Betriebsstundenzähler	hour meter 24VAC	compteur d'heures 24VAC
			80	N23791	1	Steuertransformator	control transformer	transformateur
			90	N19096	1	Summierzähler	cycle counter	compteur/totalisateur
			100	N16206	1	Installationsschalter	installation switch	interrupteur d'installation
			110	N16202	1	Taktgeber	timer	minuterie électrique
			120	N23685	16	Durchgangsklemme	terminal clamp	borne de phase
			130	N23688	2	Schutzleiterklemme	ground terminal	borne de terre
			140	N23689	1	Abschlußplatte	end plate	plaque de fermeture
			150	N23690	2	Endwinkel	end bracket	angle de fermeture
			160	N23778	7	Querverbindung	cross connection	connexion latérale
			170	N4863	mm	Tragschiene	bearing rail	rail support
			180	N16126	mm	Tragschiene	carrying rail	rail support
			190	N3100	3	Kabelverschraubung	cable stuffing box coupling	raccord presse-étoupe
			200	N3101	6	Kabelverschraubung	cable union	raccord de câble
			210	N3103	3	Gegenmutter	counternut	contre-écrou
			220	N3104	6	Gegenmutter	counternut	contre-écrou
			230	N22441	2	Schnittstellenrelais	intersection relay	relais d'interface
			240	N26439	1	Zeitrelais, Öldruck	time relay, oil pressure	relais, pression d'huile
			250	N26443	1	Frontelement	front element red oil symbol	élément de façade
			260	N26313	1	LED-Element	LED element	LED
			270	N26310	1	Befestigungsflansch	mounting bracket	bride de fixation
			280	N22351	1	Klebeschild	label	étiquette
			290	72827	1	Klebeschild	label	étiquette
			300	71410	1	Klebeschild	label	étiquette



G50.4- 11



Ersatzteilsätze
Spare parts sets
Kits de pièces dét.

Baugruppe 80487
Assembly 80487
Assemblage 80487

Kompressorsteuerung 5,5 kW; 220 - 240 V halbautomatisch
Compressor control unit 5,5 kW; 220 - 240 V semi-automatic
Unité de commande 5,5 kW; 220 - 240 V semi-automatique

Klasse/ Class/ Classe			Pos.	Bestell-Nr. Part No. No. de cde.	Anz. Qty. Qté.	Benennung	Designation	Dénomination
a	b	c						
			--	N26437	1	Druckschalter, Oldruck	pressure switch, oil press.	electrovanne, press. h'huile
			--	N26438	1	Schutzkapp0e	protective cap	

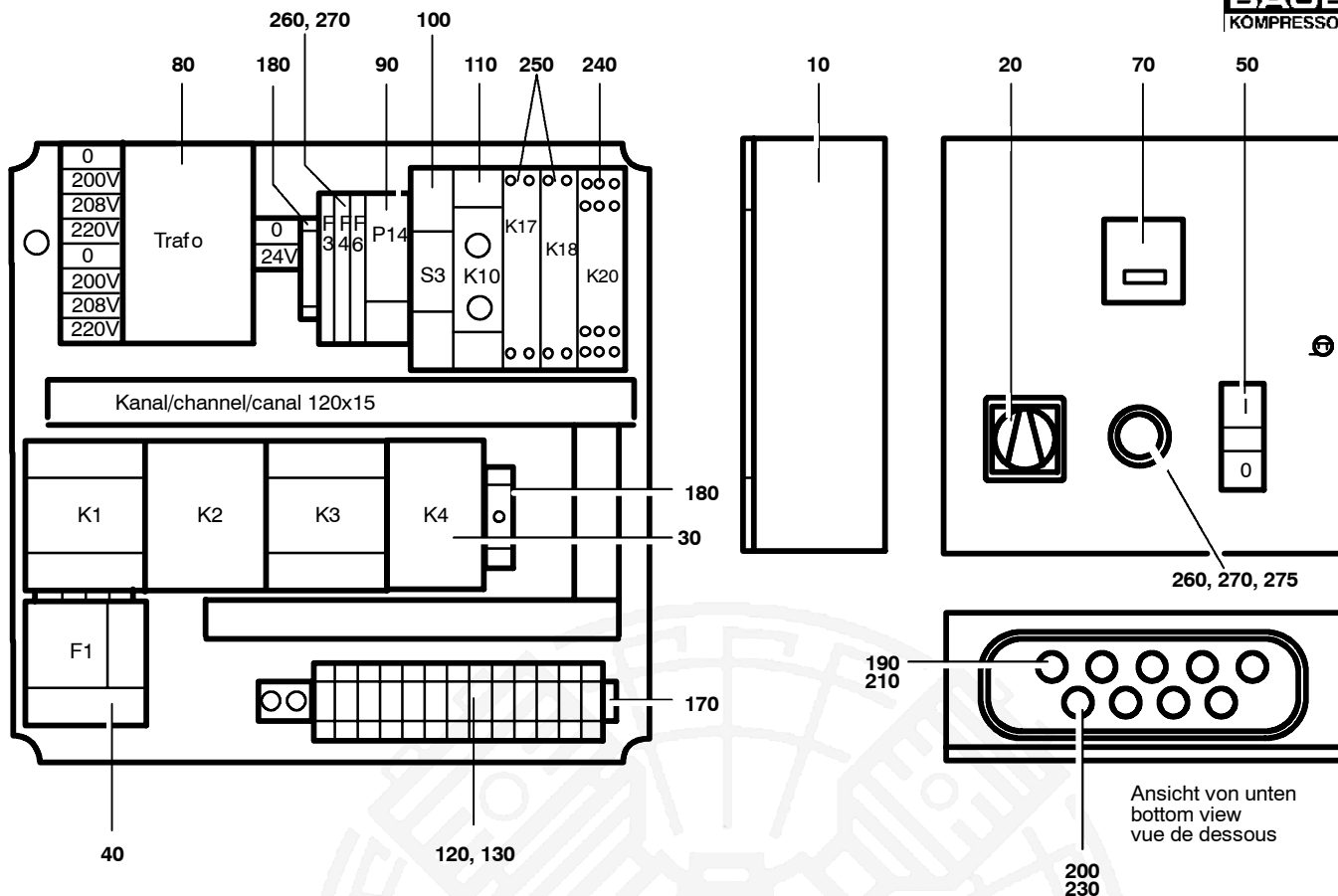

Ersatzteilsätze
 Spare parts sets
 Kits de pièces dét.

Baugruppe 80490 Kompressorsteuerung 5,5 kW; 220 - 240 V vollautomatisch
 Assembly 80490 Compressor control unit 5,5 kW; 220 - 240 V automatic
 Assemblage 80490 Unité de commande 5,5 kW; 220 - 240 V automatique

G50.4- 12

Klasse/ Class/ Classe			Pos.	Bestell-Nr. Part No. No. de cde.	Anz. Qty. Qté.	Benennung	Designation	Dénomination
a	b	c						
			10	N23779	1	Gehäuse	housing	boîtier
			20	N4555	1	Hauptschalter	main switch	interrupteur principal
			30	N23058	1	Motorschutzschalter	motor protecting switch	fusible moteur
			40	N26631	1	Sanftanläufer	progressive starter	démarrateur progressif
			50	N26308	1	Tastschalter kpl.	dual push-button switch	interrupteur
			70	N23853	1	Betriebsstundenzähler	hour meter 24VAC	compteur d'heures 24VAC
			80	N23791	1	Steuertransformator	control transformer	transformateur
			90	N19096	1	Summierzähler	cycle counter	compteur/totalisateur
			100	N16206	1	Installationsschalter	installation switch	interrupteur d'installation
			110	N26809	1	Taktgeber	timer	minuterie électrique
			120	N23685	16	Durchgangsklemme	terminal clamp	borne de phase
			130	N23688	2	Schutzleiterklemme	ground terminal	borne de terre
			140	N23689	1	Abschlußplatte	end plate	plaque de fermeture
			150	N23690	2	Endwinkel	end bracket	angle de fermeture
			160	N23778	7	Querverbindung	cross connection	connexion latérale
			170	N4863	mm	Tragschiene	bearing rail	rail support
			180	N16126	mm	Tragschiene	carrying rail	rail support
			190	N3100	3	Kabelverschraubung	cable stuffing box coupling	raccord presse-étoupe
			200	N3101	6	Kabelverschraubung	cable union	raccord de câble
			210	N3103	3	Gegenmutter	counternut	contre-écrou
			220	N3104	6	Gegenmutter	counternut	contre-écrou
			230	N22441	2	Schnittstellenrelais	intersection relay	relais d'interface
			240	N26439	1	Zeitrelais, Öldruck	time relay, oil pressure	relais, pression d'huile
			250	N26443	1	Frontelement	front element red oil symbol	élément de façade
			260	N26313	1	LED-Element	LED element	LED
			270	N26310	1	Befestigungsflansch	mounting bracket	bride de fixation
			280	N22351	1	Klebeschild	label	étiquette
			290	72827	1	Klebeschild	label	étiquette
			300	71410	1	Klebeschild	label	étiquette

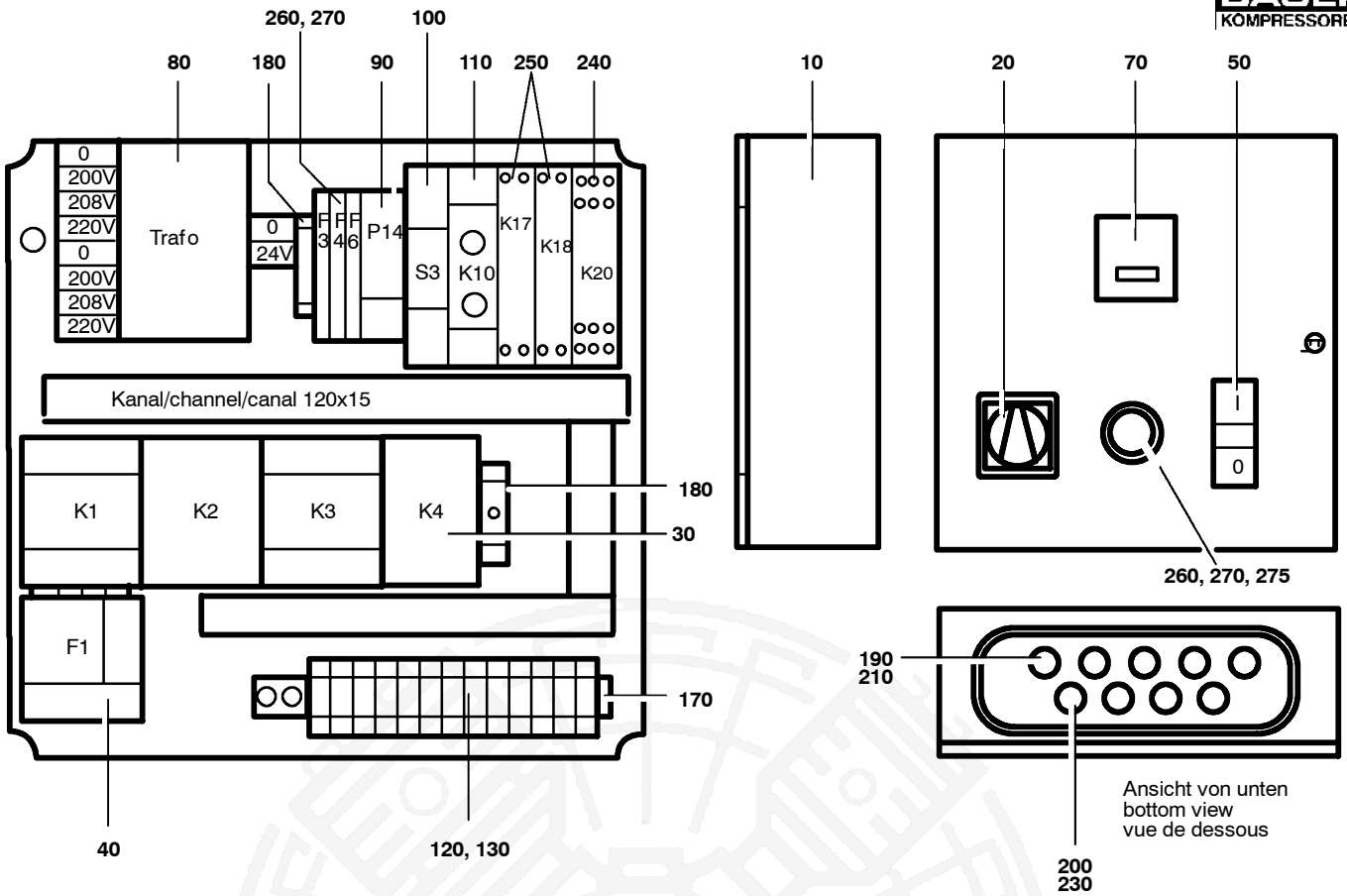

Ersatzteilsätze
Spare parts sets
Kits de pièces dét.

Baugruppe 80490
Assembly 80490
Assemblage 80490

Kompressorsteuerung 5,5 kW; 220 - 240 V vollautomatisch
Compressor control unit 5,5 kW; 220 - 240 V automatic
Unité de commande 5,5 kW; 220 - 240 V automatique

G50.4- 12

Klasse/ Class/ Classe			Pos.	Bestell-Nr. Part No. No. de cde.	Anz. Qty. Qté.	Benennung	Designation	Dénomination
a	b	c						
			--	N26437	1	Druckschalter, Oldruck	pressure switch, oil press.	electrovanne, press. h'huile
			--	N26438	1	Schutzkapp0e	protective cap	

